

PowerFlex 70 Adjustable Frequency AC Drive



Topic	Page
Product Overview	2
Catalog Number Explanation	5
Factory Installed Options	7
User Installed Options	8
Installation Considerations	16
Cable Recommendations	22
Power Ratings and Branch Circuit Protection	24
Maximum Motor Cable Lengths	28
Mounting	32
Approximate Dimensions and Weights	33
PowerFlex 70 Configured Drives	38
Standard Drive Certifications and Specifications	40
Derating Guidelines	46



Additional Resources

These documents contain additional information concerning related products from Rockwell Automation.

Resource	Description
PowerFlex 70 Adjustable Frequency AC Drive User Manual, publication 20A-UM001	Provides the basic information needed to start-up and troubleshoot the PowerFlex® 70 Adjustable Frequency AC Drive.
PowerFlex 70 and 700 Reference Manual - Volume 1, publication PFLEX-RM001	Provides detailed information for specifications and dimensions, operation, and dynamic brake selection for the drive.
PowerFlex 70 Adjustable Frequency AC Drive Installation Instructions, publication 20A-IN009	Provides the five basic steps needed to install and perform a basic startup of the PowerFlex 70 drive.
Wiring and Grounding Guidelines for Pulse Width Modulated (PWM) AC Drives, publication DRIVES-IN001	Provides the basic information needed to properly wire and ground Pulse Width Modulated (PWM) AC drives.
Industry Installation Guidelines for Pulse Width Modulated (PWM) AC Drives, publication DRIVES-AT003	Provides basic information for enclosure systems and environmental/location considerations (to help protect against environmental contaminants), and power and grounding considerations needed to properly install AC drives.
Safety Guidelines for the Application, Installation and Maintenance of Solid State Control, publication SGI-1.1	Provides general guidelines for the application, installation, and maintenance of solid-state control.
Preventive Maintenance of Industrial Control and Drive System Equipment, publication DRIVES-TD001	Provides a guide to performing preventive maintenance.
Guarding Against Electrostatic Damage, publication 8000-4.5.2	Provides practices for guarding against Electrostatic damage (ESD)
Industrial Automation Wiring and Grounding Guidelines, publication 1770-4.1	Provides general guidelines for installing a Rockwell Automation industrial system.
Product Certifications website, http://www.ab.com	Provides declarations of conformity, certificates, and other certification details.

You can view or download publications at <http://www.rockwellautomation.com/literature/>. To order paper copies of technical documentation, contact your local Allen-Bradley distributor or Rockwell Automation sales representative.

Product Overview

PowerFlex 70 drives are designed to worldwide standards providing out-of-the-box performance around the globe. Available ratings include these options:

- 0.5...25 Hp output at 240V AC input
- 0.5...50 Hp output at 480V AC input
- 0.5...50 Hp output at 600V AC input

The PowerFlex 70 drive can be used with a full featured LCD human interface module (HIM) that provides multilingual text for startup, metering, programming, and troubleshooting.

The PowerFlex 70 can be programmed for either volts per hertz, sensorless vector, or vector control with FORCE™ Technology to cover a wide range of applications from fans to extruders.

Optional internal communication modules provide fast and efficient control and/or data exchange with host controllers over popular interfaces. These interfaces include: DeviceNet, EtherNet, ControlNet, remote I/O, serial communications, and other open control and communication networks. Computer tools such as DriveExplorer™ and DriveTools™ SP assist with programming, monitoring, and troubleshooting the PowerFlex 70.



Flexible Packaging and Mounting

- **IP20, NEMA/UL Type 1** – For conventional mounting inside or outside a control cabinet. Conduit plate is vertically removable for easy installation and replacement without disturbing conduit.
- **IP66, NEMA/UL Type 4X/12** (indoor use) – For mounting directly in the production environment. Listed by UL to resist dust, dirt, other contaminants, and to survive high pressure water spray. Also certified by NSF International to assure conformity with international food equipment standards.
- **Flange Type** – For mounting heatsink through back of an enclosure, thus removing a large portion of the heat inside a cabinet. The backside is rated IP66, NEMA/UL Type 4X/12 for both indoor and outdoor use.
- **Zero-Stacking™** - Drives can be mounted directly next to one another with no reduction of ambient temperature rating (50 °C [122 °F] for IP20, NEMA/UL Type 1 and Flange Mount; 40 °C [104 °F] for IP66, NEMA/UL Type 4X/12).

Space Saving Hardware Features

- Integral electromagnetic compatibility (EMC) filtering provides a compact, all-in-one package solution for meeting EMC requirements, including CE in Europe.
- Integral dynamic brake transistor delivers a cost-effective means of switching regenerative energy without costly external chopper circuits.
- Internal dynamic brake resistor requires no extra panel space, and supplies a large amount of braking torque for short periods.

Easy to Use Human Interface Tools

The PowerFlex 7-Class AC drives provide common human interface tools that are familiar and easy to use. These include the LCD human interface modules and computer-based configuration tools.

The LCD HIMs provide these features and functions:

- Large and easy to read 7-line x 21-character backlit display
- Variety of languages (English, French, German, Italian, Spanish, Portuguese, Dutch)
- Alternate function keys for shortcuts to common tasks
- ‘Calculator-like’ number pad for fast and easy data entry (full numeric version only)
- Control keys for local start, stop, speed, and direction

Remote versions for panel mount application

Outstanding Control and Performance

- **Vector Control with FORCE™ Technology** ⁽¹⁾ provides outstanding torque and speed regulation, with or without encoder feedback.
- **Sensorless Vector Control** develops high torque over a wide speed range, and adapts to individual motor characteristics.

Drives Features

- Fast acting **Current Limit** and **Bus Voltage Regulation** result in maximum acceleration and deceleration without tripping.
- **Flying Start** delivers smooth connection into rotating loads, regardless of commanded direction, without the need for any speed feedback device.
- **PI Control** can eliminate the need for a separate process loop controller.
- **Inertia Ride-Through** offers tripless operation during a prolonged power outage by using the rotating energy stored in high-inertia, low-friction loads.
- **User Sets**, allowing up to three complete sets of parameter data, can be individually loaded for different batch processes.
- **Slip compensation** delivers minimum of 0.5% open loop speed regulation across a wide speed range, eliminating the need for speed feedback devices in some applications.
- **Safe Off Option** ⁽¹⁾, the first offering available within the DriveGuard® series of safety solutions, prevents a drive from delivering rotational energy to motors by integrating a safety circuit with the drive’s power switching signals. This solution meets EN 954-1, Category 3.
- **Droop Control** ⁽¹⁾ for load sharing applications.
- **Sleep/Wake Control** ⁽¹⁾ for analog control of start and stop.

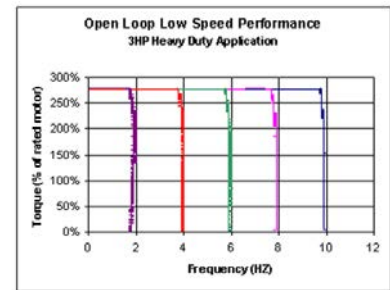
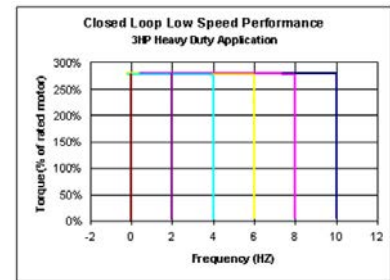

⁽¹⁾ The feature is available only for enhanced control.

Unsurpassed Capability in Network Communications

PowerFlex drives are fully compatible with the wide variety of Allen-Bradley® DPI™ (drive peripheral interface) communication adapters, offering the following benefits.

BACnet	DeviceNet	ControlNet	EtherNet/IP	Remote I/O ⁽¹⁾	RS-485 DF1	Profibus DP	LonWorks	Modbus RTU	Modbus TCP	Metasys N2	Siemens PT FLN	Description
X	X	X	X									Unconnected Messaging permits other network devices (for example, PanelView™) to communicate directly to a drive without routing the communication through the network scanner.
X	X	X	X	X	X	X	X	X	X	X	X	Adapter Routing -- Plug PC into one drive and talk to other Allen-Bradley drives on same network, without being routed through network scanner.
X	X	X	X	X	X	X	X	X	X	X	X	Access to 100% of all parameters over the network.
X	X		X		X							AutoBaud capability makes initial connections less problematic.
X												Change Of State significantly reduces network traffic by configuring control messages to be sent only upon customer defined states. Very flexible configuration for each node (for example, reference must change by more than 5%).
X		X										Peer Control provides master slave type control between drives, where one or more slave drives (consumers) can run based on the status of a master drive (producer), that can also significantly reduce network traffic.
X												Automatic Device Replacement (ADR) saves significant time and effort when replacing a drive, by allowing the scanner to be configured to automatically detect a new drive and download the required parameter settings.
X	X	X	X	X	X	X	X	X	X	X	X	Flexible Fault Configuration – Adapters can be programmed to take fault based actions such as ramp to stop, coast to stop, and hold last state, as well as send user configurable logic control and speed reference values. In addition, different actions can be taken based on whether the network experienced a serious problem (broken cable) versus a network idle condition (PLC set to 'Program.')

⁽¹⁾ The remote I/O has silver series status. For more information, refer to <http://www.ab.com/silver>.

Catalog Number Explanation

1-3	4	5-7	8	9	10	11	12	13	14	15	16
20A	B	2P2	A	3	A	Y	Y	N	N	C	0
<i>a</i>	<i>b</i>	<i>c</i>	<i>d</i>	<i>e</i>	<i>f</i>	<i>g</i>	<i>h</i>	<i>i</i>	<i>j</i>	<i>k</i>	<i>l</i>

a

Drive	
Code	Type
20A	PowerFlex 70

b

Voltage Rating		
Code	Voltage	Ph.
B	240V AC	3
C	400V AC	3
D	480V AC	3
E	600V AC	3

c1

ND Rating			
208V, 60 Hz Input			
Code	Amps	kW (Hp)	Frame
2P2	2.5	0.37 (0.5)	A
4P2	4.8	0.75 (1.0)	A
6P8	7.8	1.5 (2.0)	B
9P6	11	2.2 (3.0)	B
015	17.5	4.0 (5.0)	C
022	25.3	5.5 (7.5)	D
028	32.2	7.5 (10)	D
042	43	11 (15)	D
054	62.1	15 (20)	E
070	78.2	18.5 (25)	E

c2

ND Rating			
240V, 60 Hz Input			
Code	Amps	kW (Hp)	Frame
2P2	2.2	0.37 (0.5)	A
4P2	4.2	0.75 (1.0)	A
6P8	6.8	1.5 (2.0)	B
9P6	9.6	2.2 (3.0)	B
015	15.3	4.0 (5.0)	C
022	22	5.5 (7.5)	D
028	28	7.5 (10)	D
042	42	11 (15)	D
054	54	15 (20)	E
070	70	18.5 (25)	E

c3

ND Rating			
400V, 50 Hz Input			
Code	Amps	kW (Hp)	Frame
1P3	1.3	0.37 (0.5)	A
2P1	2.1	0.75 (1.0)	A
3P5	3.5	1.5 (2.0)	A
5P0	5.0	2.2 (3.0)	B
8P7	8.7	4.0 (5.0)	B
011	11.5	5.5 (7.5)	C
015	15.4	7.5 (10)	C
022	22	11 (15)	D
030	30	15 (20)	D
037	37	18.5 (25)	D
043	43	22 (30)	D
060	60	30 (40)	E
072	72	37 (50)	E

c4

ND Rating			
480V, 60 Hz Input			
Code	Amps	kW (Hp)	Frame
1P1	1.1	0.37 (0.5)	A
2P1	2.1	0.75 (1.0)	A
3P4	3.4	1.5 (2.0)	A
5P0	5.0	2.2 (3.0)	B
8P0	8.0	3.7 (5.0)	B
011	11	5.5 (7.5)	C
014	14	7.5 (10)	C
022	22	11 (15)	D
027	27	15 (20)	D
034	34	18.5 (25)	D
040	40	22 (30)	D
052	52	30 (40)	E
065	65	37 (50)	E

c5

ND Rating			
600V, 60 Hz Input *			
Code	Amps	kW (Hp)	Frame
0P9	0.9	0.37 (0.5)	A
1P7	1.7	0.75 (1.0)	A
2P7	2.7	1.5 (2.0)	A
3P9	3.9	2.2 (3.0)	B
6P1	6.1	4.0 (5.0)	B
9P0	9.0	5.5 (7.5)	C
011	11	7.5 (10)	C
017	17	11 (15)	D
022	22	15 (20)	D
027	27	18.5 (25)	D
032	32	22 (30)	D
041	41	30 (40)	E
052	52	37 (50)	E

* CE certification testing has not been performed on 600V class drives.

d

Enclosure	
Code	Enclosure
A	Panel Mount - IP 20, NEMA/UL Type 1
C	Wall/Machine Mount = IP66, NEMA/UL Type 4X/12 for indoor use only
F	Flange Mount - Front Chassis = IP 20, NEMA/UL Type 1; Rear Heatsink = IP66, NEMA/UL Type 4X/12 for indoor/outdoor use
G	Wall/Machine Mount - IP54, NEMA/UL Type 12 *

* Only available on Frame E.

e

HIM	
Code	Interface Module
0	Blank Cover
3	Full Numeric LCD
5	Prog. Only LCD *

* Only available with NEMA 4X, option C.

See [Catalog Number Explanation \(continued\)](#) on page 6 for more drive options.

Catalog Number Explanation (continued)

1-3		4	5-7		8	9		10		11	12	13	14	15	16
20A		B	2P2		A	3		A		Y	Y	N	N	C	0
<i>a</i>		<i>b</i>	<i>c</i>		<i>d</i>	<i>e</i>		<i>f</i>		<i>g</i>	<i>h</i>	<i>i</i>	<i>j</i>	<i>k</i>	<i>l</i>

Position Number

f

Documentation	
Code	Type
A	Manual
N	No Manual

g

Brake IGBT	
Code	w/Brake IGBT
Y	Yes

h

Internal Brake Resistor	
Code	w/Resistor
Y	Yes
N	No

i

Emission Class	
Code	Rating
A	Filtered* A* & B Frames (Optional) C, D, & E Frames (Standard)
N	Not Filtered* A & B Frames (Optional) C, D, & E Frames

* 600V Frames A through D available only without filter (Cat. Code N). 600V Frame E available only with filter (Cat. Code A).

* Increases size to Frame B.

j

Comm Slot	
Code	Network Type
C	ControlNet (Coax)
D	DeviceNet
E	EtherNet/IP
N	None

k

Control & I/O		
Code	Control	Safe-Off
N*	Standard	N/A
C	Enhanced	No
G*	Enhanced	Yes

* No longer available for sale.

* Not available as factory installed option for 600V ratings.

l

Feedback	
Code	Feedback
0	No Feedback - Enhanced Control
1	5V/12V Encoder w/Enhanced Control

Factory Installed Options

Human Interface and Wireless Interface Modules (Pos. e) IP20, NEMA/UL Type 1 and Flange Type Drives



Cat. Code: 0
No HIM (Blank Plate)



Cat. Code: 3
LCD Display, Full
Numeric Keypad

IP66, NEMA/UL Type 4X/12 Drives (Position e)



Cat. Code: 0
No HIM (Blank)



Cat. Code: 3
LCD Display, Full Numeric Keypad



Cat. Code: 5
LCD Display, Programmer Only

Documentation

Description	Cat. Code (Position f)
English User Manual, Multi-Language Quick Start	A
No User Manual	N

Internal Dynamic Brake Resistors

Drive Input Voltage	Brake Resistance	Frame	Cat. Code
	Ω		(Position h)
200...240V AC	62	A	Y
		B	Y
		C	Y
	22	D	Y
		E	Not Available
380...480V AC	115	A	Y
		B	Y
		C	Y
	62	D	Y
		E	Not Available
600V AC	115	A	Y
		B	Y
		C	Y
	D and E	Not Available	

These resistors have a limited duty cycle. Refer to the PowerFlex Dynamic Braking Selection Guide to determine if an internal resistor will be sufficient. An external resistor may be required.

Internal EMC Filter

Drive Input Voltage	CE Filter	Frame *	Cat. Code
			(Position i)
200...240V AC	Optional	B	A
	Standard	C	
	Standard	D	
380...480V AC	Optional	B	A
	Standard	C	
	Standard	D	
	Standard	E	

* Internal CE filters are not available for PowerFlex 70 A Frame drives. If an A Frame rating is ordered with an internal filter option, it will be supplied in a B Frame.

Internal Communication Adapters

Description	Cat. Code (Position j)
ControlNet™ Communication Adapter (Coax)	C
DeviceNet™ Communication Adapter	D
EtherNet/IP™ Communication Adapter	E

Control Options

Description	Cat. Code (Position k)
Enhanced Control without DriveGuard	C
Enhanced Control with DriveGuard	G

Feedback Options

Description	Cat. Code (Position l)
None	0
5V/12V Encoder	1

User Installed Options

Human Interface and Wireless Interface Modules



No HIM (Blank Plate)
20-HIM-A0



LCD Display, Full
Numeric Keypad
20-HIM-A3



LCD Display,
Programmer Only
20-HIM-A5



Enhanced LCD Display,
Full Numeric Keypad
20-HIM-A6



Remote (Panel Mount)
LCD Display, Full
Numeric Keypad
20-HIM-C3S



Remote (Panel Mount)
LCD Display,
Programmer Only
20-HIM-C5S



Enhanced LCD Display,
Full Numeric Keypad
20-HIM-A6S

Description	Handheld/Local (Drive Mount)	Remote (Panel Mount) IP66, NEMA/UL Type 4x/12 *
	Cat. No.	Cat. No.
No HIM (Blank Plate)	20-HIM-A0	-
LCD Display, Full Numeric Keypad	20-HIM-A3	20-HIM-C3S ‡
LCD Display, Programmer Only	20-HIM-A5	20-HIM-C5S ‡
Enhanced LCD Display, Full Numeric Keypad	20-HIM-A6	20-HIM-A6S

* For indoor use only.

‡ Includes a 1202-C30 interface cable, 3 m (9.8 ft), for connection to drive.

Human Interface Module Accessories

Description	Cat. No.
Bezel Kit for LCD HIMs, NEMA/UL Type 1 ‡	20-HIM-B1
PowerFlex HIM Interface Cable, 1 m (39 in) ♣	20-HIM-H10
Cable Kit (Male-Female) ▶	
0.33 Meters (1.1 Feet)	1202-H03
1 Meter (3.3 Feet)	1202-H10
3 Meter (9.8 Feet)	1202-H30
9 Meter (29.5 Feet)	1202-H90
Comm Option Cable Kit	
0.33 Meters (1.1 Feet)	1202-C03
1 Meter (3.3 Feet)	1202-C10
3 Meter (9.8 Feet)	1202-C30
9 Meter (29.5 Feet)	1202-C90
DPI Cable Kit with Connectors, Tools and 100 m (328 ft.) Cable	1202-CBL-KIT-100M
DPI Cable Connector Kit	1202-TB-KIT-SET
DPI/SCANport™ One to Two Port Splitter Cable	1203-S03

‡ Includes a 1202-C30 interface cable (3 meters) for connection to drive.

♣ Required only when HIM is used as handheld or remote.

▶ Required in addition to 20-HIM-H10 for distances up to a total maximum of 10 Meters (32.8 Feet).

Dynamic Brake Resistors

Small Duty Internal Dynamic Brake Resistors

Limited duty resistors mount directly to the back surface of the drive and require no extra panel space. Internal resistors are non-destructive and do not require a resistor overheat external safety circuit

PowerFlex 70 AC Drive			Small Duty Internal DB Resistor								
Normal Duty* kW (Hp)	Heavy Duty* kW (Hp)	Min DB Res Ohms ±10%	Part Number	Resistance* Ohms ±5%	Continuous Power kW	Max Energy kJ	Max Braking Torque % of ND Motor	Application Type 1		Application Type 2	
								Braking Torque % of ND Motor	Duty Cycle	Braking Torque % of ND Motor	Duty Cycle
200...240 Volt AC Input Drives											
0.37 (0.5)	0.25 (0.33)	33	20AB-DB1-A	62	0.048	8.3	307%	100%	25.9%	150%	17.3%
0.75 (1.0)	0.55 (0.75)	33	20AB-DB1-A	62	0.048	7.3	300%	100%	12.8%	150%	8.5%
1.5 (2.0)	1.1 (1.5)	33	20AB-DB1-B	62	0.028	0.8	160%	100%	3.7%	150%	2.5%
2.2 (3.0)	1.5 (2.0)	33	20AB-DB1-B	62	0.028	0.8	109%	100%	2.5%	109%	2.3%
4.0 (5.0)	3.0 (3.0)	30	20AB-DB1-C	62	0.040	0.8	60%	60%	3.3%	N/A	N/A
5.5 (7.5)	4.0 (5.0)	21	20AB-DB1-D	22	0.036	0.9	117%	100%	1.3%	117%	1.1%
7.5 (10)	5.5 (7.5)	21	20AB-DB1-D	22	0.036	0.9	86%	86%	1.1%	N/A	N/A
400...480 Volt AC Input Drives											
0.37 (0.5)	0.25 (0.33)	68	20AD-DB1-A	115	0.048	8.3	320%	100%	25.9%	150%	17.3%
0.75 (1.0)	0.55 (0.75)	68	20AD-DB1-A	115	0.048	9.0	259%	100%	12.8%	150%	8.5%
1.5 (2.0)	1.1 (1.5)	68	20AD-DB1-A	115	0.048	2.4	243%	100%	6.4%	150%	4.3%
2.2 (3.0)	1.5 (2.0)	68	20AD-DB1-B	115	0.028	0.9	206%	100%	2.5%	150%	1.7%
4.0 (5.0)	3.0 (3.0)	68	20AD-DB1-B	115	0.028	0.9	129%	100%	1.4%	129%	1.1%
5.5 (7.5)	4.0 (5.0)	74	20AD-DB1-C	115	0.04	0.9	94%	94%	1.5%	N/A	N/A
7.5 (10)	5.5 (7.5)	74	20AD-DB1-C	115	0.04	0.9	69%	69%	1.5%	N/A	N/A
11 (15)	7.5 (10)	44	20AD-DB1-D	62	0.036	0.8	87%	87%	0.8%	N/A	N/A
15 (20)	11 (15)	31	20AD-DB1-D	62	0.036	0.8	64%	64%	0.8%	N/A	N/A
500...600 Volt AC Input Drives											
0.37 (0.5)	0.25 (0.33)	117	20AD-DB1-A	115	0.048	8.3	287%	100%	25.9%	150%	17.3%
0.75 (1.0)	0.55 (0.75)	117	20AD-DB1-A	115	0.048	9.0	263%	100%	12.8%	150%	8.5%
1.5 (2.0)	1.1 (1.5)	117	20AD-DB1-A	115	0.048	2.4	243%	100%	6.4%	150%	4.3%
2.2 (3.0)	1.5 (2.0)	117	20AD-DB1-B	115	0.028	0.9	202%	100%	2.5%	150%	1.7%
4.0 (5.0)	3.0 (3.0)	80	20AD-DB1-B	115	0.028	0.9	193%	100%	1.4%	150%	0.9%
5.5 (7.5)	4.0 (5.0)	80	20AD-DB1-C	115	0.04	0.9	147%	100%	1.5%	147%	1.0%
7.5 (10)	5.5 (7.5)	80	20AD-DB1-C	115	0.04	0.9	108%	100%	1.1%	108%	1.0%
11 (15)	7.5 (10)	48	N/A	N/A	N/A	N/A	N/A	N/A	N/A	N/A	N/A
15 (20)	11 (15)	48	N/A	N/A	N/A	N/A	N/A	N/A	N/A	N/A	N/A

* Duty cycle listed is based on full speed to zero speed deceleration. For constant regen at full speed, duty cycle capability is half of what is listed. Application Type 1 represents maximum capability up to 100% braking torque where possible. Application Type 2 represents more than 100% braking torque where possible, up to a maximum of 150%.

※ Always check resistor ohms against minimum resistance for drive being used.

Internal Dynamic Brake Resistor Kits

Drive Input Voltage	Brake Resistance	Frame	Cat. No.
	Ω		
200...240V AC	62	A	20AB-DB1-A
		B	20AB-DB1-B
		C	20AB-DB1-C
		D	20AB-DB1-D
	E	Not Available	
380...480V AC	115	A	20AD-DB1-A
		B	20AD-DB1-B
		C	20AD-DB1-C
	62	D	20AD-DB1-D
		E	Not Available
600V AC	115	A	20AD-DB1-A
		B	20AD-DB1-B
		C	20AD-DB1-C
	D and E	Not Available	

These resistors have a limited duty cycle. Refer to the PowerFlex Dynamic Braking Resistor Calculator Application Technique, publication [PFLEX-AT001](#), to determine if an internal resistor is sufficient. An external resistor may be required.

Medium Duty External Dynamic Brake Resistors

These resistors provide a larger duty cycle capability than the internal type. Includes an internal thermal switch for use in external safety circuit.

PowerFlex 70 AC Drive			Medium Duty External DB Resistor									
Normal Duty* kW (Hp)	Heavy Duty* kW (Hp)	Min DB Res Ohms ±10%	Part Number	Resistance* Ohms ±5%	Continuous Power kW	Max Energy kJ	Max Braking Torque % of ND Motor	Application Type 1		Application Type 2		
								Braking Torque % of ND Motor	Duty Cycle	Braking Torque % of ND Motor	Duty Cycle	
200...240 Volt ac Input Drives												
0.37 (0.5)	0.25 (0.33)	33	AK-R2-091P500	91	0.086	17	293%	100%	46%	150%	31%	
0.75 (1.0)	0.55 (0.75)	33	AK-R2-091P500	91	0.086	17	218%	100%	23%	150%	15%	
1.5 (2.0)	1.1 (1.5)	33	AK-R2-091P500	91	0.086	17	109%	100%	11%	109%	11%	
2.2 (3.0)	1.5 (2.0)	33	AK-R2-047P500	47	0.166	33	144%	100%	15%	144%	11%	
4.0 (5.0)	3.0 (3.0)	30	AK-R2-047P500	47	0.166	33	79%	79%	11%	N/A	N/A	
5.5 (7.5)	4.0 (5.0)	23	AK-R2-030P1K2	30	0.26	52	90%	90%	10%	N/A	N/A	
7.5 (10)	5.5 (7.5)	23	AK-R2-030P1K2	30	0.26	52	66%	66%	10%	N/A	N/A	
400...480 Volt ac Input Drives												
0.37 (0.5)	0.25 (0.33)	68	AK-R2-360P500	360	0.086	17	305%	100%	47%	150%	31%	
0.75 (1.0)	0.55 (0.75)	68	AK-R2-360P500	360	0.086	17	220%	100%	23%	150%	15%	
1.5 (2.0)	1.1 (1.5)	68	AK-R2-360P500	360	0.086	17	110%	100%	12%	110%	11%	
2.2 (3.0)	1.5 (2.0)	68	AK-R2-120P1K2	120	0.26	52	197%	100%	24%	150%	16%	
4.0 (5.0)	3.0 (3.0)	68	AK-R2-120P1K2	120	0.26	52	124%	100%	13%	124%	10%	
5.5 (7.5)	4.0 (5.0)	74	AK-R2-120P1K2	120	0.26	52	90%	90%	10%	N/A	N/A	
7.5 (10)	5.5 (7.5)	74	AK-R2-120P1K2	120	0.26	52	66%	66%	10%	N/A	N/A	
11 (15) ‡	7.5 (10) ‡	44	‡	60	0.52	104	90%	90%	10%	N/A	N/A	
15 (20) ‡	11 (15) ‡	31	‡	60	0.52	104	66%	66%	10%	N/A	N/A	
500...600 Volt ac Input Drives												
0.37 (0.5)	0.25 (0.33)	117	AK-R2-360P500	360	0.086	17	274%	100%	46%	150%	31%	
0.75 (1.0)	0.55 (0.75)	117	AK-R2-360P500	360	0.086	17	251%	100%	23%	150%	15%	
1.5 (2.0)	1.1 (1.5)	117	AK-R2-360P500	360	0.086	17	172%	100%	11%	150%	8%	
2.2 (3.0)	1.5 (2.0)	117	AK-R2-120P1K2	120	0.26	52	193%	100%	24%	150%	16%	
4.0 (5.0)	3.0 (3.0)	80	AK-R2-120P1K2	120	0.26	52	185%	100%	13%	150%	9%	
5.5 (7.5)	4.0 (5.0)	80	AK-R2-120P1K2	120	0.26	52	141%	100%	9%	141%	7%	
7.5 (10)	5.5 (7.5)	80	AK-R2-120P1K2	120	0.26	52	103%	100%	7%	103%	7%	
11 (15) ‡	7.5 (10) ‡	48	‡	60	0.52	104	141%	100%	9%	141%	7%	
15 (20) ‡	11 (15) ‡	48	‡	60	0.52	104	103%	100%	7%	103%	7%	

* Duty cycle listed is based on full speed to zero speed deceleration. For constant regen at full speed, duty cycle capability is half of what is listed. Application Type 1 represents maximum capability up to 100% braking torque where possible. Application Type 2 represents more than 100% braking torque where possible, up to a maximum of 150%.

‡ Always check resistor ohms against minimum resistance for drive being used.

‡ For 11 and 15 kW (15 and 20 Hp) applications, use two 7.5 kW (10 Hp) size resistors wired in parallel.

External Dynamic Brake Resistor Kits

Drive Input Voltage	Brake Resistance	Continuous Power	Cat. No.
	Ω	W	
200...240V ac	30	260	AK-R2-030P1K2
	47	166	AK-R2-047P500
	91	86	AK-R2-091P500
480...600V ac	120	260	AK-R2-120P1K2
	360	86	AK-R2-360P500

Communication Options

Communication Option Kits

Description	Cat. No.
BACnet MS/TP RS485 Communication Adapter	20-COMM-B
ControlNet Communication Adapter (Coax)	20-COMM-C
DeviceNet Communication Adapter	20-COMM-D
EtherNet/IP Communication Adapter	20-COMM-E
HVAC Communication Adapter	20-COMM-H
CANopen Communication Adapter	20-COMM-K
LonWorks Communication Adapter	20-COMM-L
Modbus/TCP Communication Adapter	20-COMM-M
PROFIBUS DP Communication Adapter	20-COMM-P
ControlNet Communication Adapter (Fiber)	20-COMM-Q
Remote I/O Communication Adapter † 1	20-COMM-R
RS485 DF1 Communication Adapter	20-COMM-S
External Communications Kit Power Supply	20-XCOMM-AC-PS1
DPI External Communications Kit	20-XCOMM-DC-BASE
External DPI I/O Option Board †	20-XCOMM-IO-OPT1
Compact I/O Module (3 Channel)	1769-SM1
Serial Null Modem Adapter	1203-SNM
Smart Self-powered Serial Converter (RS232) includes 1203-SFC and 1202-C10 Cables	1203-SSS
Universal Serial Bus™ (USB) Converter includes 2m USB, 20-HIM-H10 & 22-HIM-H10 Cables	1203-USB

† For use only with DPI External Communications Kits 20-XCOMM-DC-BASE.

1 The remote I/O has silver series status. For more information, refer to <http://www.ab.com/silver>.

Other Options

Description	Cat. No.
DriveGuard † Safe-Off Board §	20A-DG01
5V/12V Encoder §	20A-ENC-1
115V ac Interface	AK-M9-115VAC-1
Frame E Flange Gasket	AK-M9-GASKET1-E4
Service Connection Board †*	SK-M9-SCB1

§ Works only with PowerFlex 70 Enhanced Control.

* Provides temporary DPI/HIM connection for NEMA/UL Type 1 and Flange drives with cover removed.

Terminators

Description †	Cat. No.
for use with 3.7 kW (5 Hp) & below drives	1204-TFA1
for use with 1.5 kW (2 Hp) & up drives	1204-TFB2

† Refer to Appendix A of publication DRIVES-IN001 for selection information.

Reflected Wave Reduction Modules

Description †	Cat. No.
17A with Common Mode Choke	1204-RWC-17-A
9A without Choke, Book Mount	1204-RWR2-09-B
9A without Choke, Stack Mount	1204-RWR2-09-C

† Refer to Appendix A of publication DRIVES-IN001 for selection information.

Reflective Wave Reduction Devices

1321-RWR devices are used at the output of the drive to reduce dv/dt and motor terminal peak voltages

480V, 60 Hz, Three-phase		
Drive Cat. No.	kW (Hp)	RWR Filter Cat. No.
20AD1P1-ND	0.37 (0.5)	–
20AD2P1-ND	0.75 (1.0)	–
20AD3P4-ND	1.5 (2.0)	–
20AD5P0-ND	2.2 (3.0)	–
20AD8P0-ND	4.0 (5.0)	1321-RWR8-DP
20AD011-ND	5.5 (7.5)	1321-RWR12-DP
20AD014-ND	7.5 (10)	1321-RWR18-DP
20AD022-ND	11 (15)	1321-RWR25-DP
20AD027-ND	15 (20)	1321-RWR35-DP
20AD034-ND	18.5 (25)	1321-RWR35-DP
20AD040-ND	22 (30)	1321-RWR45-DP
20AD052-ND	30 (40)	1321-RWR55-DP
20AD065-ND	37 (50)	1321-RWR80-DP

600V, 60 Hz, Three-phase		
Drive Cat. No.	kW (Hp)	RWR Filter Cat. No.
20AE0P9-ND	0.37 (0.5)	–
20AE1P7-ND	0.75 (1.0)	–
20AE2P7-ND	1.5 (2.0)	–
20AE3P9-ND	2.2 (3.0)	–
20AE6P1-ND	4.0 (5.0)	1321-RWR8-EP
20AE9P0-ND	5.5 (7.5)	1321-RWR12-EP
20AE011-ND	7.5 (10)	1321-RWR18-EP
20AE017-ND	11 (15)	1321-RWR25-EP
20AE022-ND	15 (20)	1321-RWR35-EP
20AE027-ND	18.5 (25)	1321-RWR45-EP
20AE032-ND	22 (30)	1321-RWR55-EP
20AE041-ND	30 (40)	1321-RWR80-EP
20AE052-ND	37 (50)	1321-RWR100-EP

Isolation Transformers

For installations that have specific types of AC supply configurations or require drive protection due to AC line disturbances, isolation transformers are available.

Motor Rating kW (Hp)	240V, 60 Hz, Three-phase, 240V Primary and 240V Secondary	460V, 60 Hz, Three-phase, 460V Primary and 460V Secondary	575V, 60 Hz, Three-phase 575V Primary and 575V Secondary
	IP32 (NEMA/UL Type 3R)	IP32 (NEMA/UL Type 3R)	IP32 (NEMA/UL Type 3R)
	Cat. No.	Cat. No.	Cat. No.
0.25 (0.33)	1321-3TW005-AA	1321-3TW005-BB	–
0.37 (0.5)	1321-3TW005-AA	1321-3TW005-BB	–
0.55 (0.75)	1321-3TW005-AA	1321-3TW005-BB	–
0.75 (1.0)	1321-3TW005-AA	1321-3TW005-BB	1321-3TW005-CC
1.1 (1.5)	1321-3TW005-AA	1321-3TW005-BB	–
1.5 (2.0)	1321-3TW005-AA	1321-3TW005-BB	1321-3TW005-CC
2.2 (3.0)	1321-3TW005-AA	1321-3TW005-BB	1321-3TW005-CC
4.0 (5.0)	1321-3TW007-AA	1321-3TW007-BB	1321-3TW007-CC
5.5 (7.5)	1321-3TW011-AA	1321-3TW011-BB	1321-3TW011-CC
7.5 (10)	1321-3TW014-AA	1321-3TW014-BB	1321-3TW014-CC
11 (15)	1321-3TW020-AA	1321-3TW020-BB	1321-3TW020-CC
15 (20)	1321-3TW027-AA	1321-3TW027-BB	1321-3TW027-CC
18.5 (25)	1321-3TW034-AA	1321-3TW034-BB	1321-3TW034-CC
22 (30)	–	1321-3TW040-BB	1321-3TW040-CC
30 (40)	–	1321-3TW051-BB	1321-3TW051-CC
37 (50)	–	1321-3TH063-BB	1321-3TH063-CC

Input/Output Line Reactors

For impedance matching, protection from AC line disturbances or motor protection, reactors are available for both the input and output sides of the drive.

Table 1 - 240V, 60 Hz, Three-phase, 3% Impedance

Drive Cat. No.	Duty	Hp	Input Line Reactor ⁽¹⁾		Output Line Reactor ⁽¹⁾	
			IP00 (NEMA/UL Type Open)	IP11 (NEMA/UL Type 1)	IP00 (NEMA/UL Type Open)	IP11 (NEMA/UL Type 1)
			Cat. No.	Cat. No.	Cat. No.	Cat. No.
20AB2P2	Heavy Duty	0.33	1321-3R2-D	1321-3RA2-D	1321-3R2-D	1321-3RA2-D
20AB2P2	Normal Duty	0.5	1321-3R2-D	1321-3RA2-D	1321-3R2-D	1321-3RA2-D
20AB4P2	Heavy Duty	0.75	1321-3R4-A	1321-3RA4-A	1321-3R4-A	1321-3RA4-A
20AB4P2	Normal Duty	1	1321-3R4-A	1321-3RA4-A	1321-3R4-A	1321-3RA4-A
20AB6P8	Heavy Duty	1.5	1321-3R8-B	1321-3RA8-B	1321-3R8-A	1321-3RA8-A
20AB6P8	Normal Duty	2	1321-3R8-A	1321-3RA8-A	1321-3R8-A	1321-3RA8-A
20AB9P6	Heavy Duty	2	1321-3R8-A	1321-3RA8-A	1321-3R12-A	1321-3RA12-A
20AB9P6	Normal Duty	3	1321-3R12-A	1321-3RA12-A	1321-3R12-A	1321-3RA12-A
20AB015	Heavy Duty	3	1321-3R12-A	1321-3RA12-A	1321-3R18-A	1321-3RA18-A
20AB015	Normal Duty	5	1321-3R18-A	1321-3RA18-A	1321-3R18-A	1321-3RA18-A
20AB022	Heavy Duty	5	1321-3R18-A	1321-3RA18-A	1321-3R25-A	1321-3RA25-A
20AB022	Normal Duty	7.5	1321-3R25-A	1321-3RA25-A	1321-3R25-A	1321-3RA25-A
20AB028	Heavy Duty	7.5	1321-3R25-A	1321-3RA25-A	1321-3R35-A	1321-3RA35-A
20AB028	Normal Duty	10	1321-3R35-A	1321-3RA35-A	1321-3R35-A	1321-3RA35-A
20AB042	Heavy Duty	10	1321-3R35-A	1321-3RA35-A	1321-3R45-A	1321-3RA45-A
20AB042	Normal Duty	15	1321-3R45-A	1321-3RA45-A	1321-3R45-A	1321-3RA45-A
20AB054	Heavy Duty	15	1321-3R45-A	1321-3RA45-A	1321-3R55-A	1321-3RA55-A
20AB054	Normal Duty	20	1321-3R55-A	1321-3RA55-A	1321-3R55-A	1321-3RA55-A
20AB070	Heavy Duty	20	1321-3R55-A	1321-3RA55-A	1321-3R80-A	1321-3RA80-A
20AB070	Normal Duty	25	1321-3R80-A	1321-3RA80-A	1321-3R80-A	1321-3RA80-A

(1) Input line reactors were sized based on the NEC fundamental motor amps. Output line reactors were sized based on the VFD rated output currents.

Table 2 - 240V, 60 Hz, Three-phase, 5% Impedance

Drive Cat. No.	Duty	Hp	Input Line Reactor ⁽¹⁾		Output Line Reactor ⁽¹⁾	
			IP00 (NEMA/UL Type Open)	IP11 (NEMA/UL Type 1)	IP00 (NEMA/UL Type Open)	IP11 (NEMA/UL Type 1)
			Cat. No.	Cat. No.	Cat. No.	Cat. No.
20AB2P2	Heavy Duty	0.33	1321-3R2-A	1321-3RA2-A	1321-3R2-A	1321-3RA2-A
20AB2P2	Normal Duty	0.5	1321-3R2-A	1321-3RA2-A	1321-3R2-A	1321-3RA2-A
20AB4P2	Heavy Duty	0.75	1321-3R4-B	1321-3RA4-B	1321-3R4-B	1321-3RA4-B
20AB4P2	Normal Duty	1	1321-3R4-B	1321-3RA4-B	1321-3R4-B	1321-3RA4-B
20AB6P8	Heavy Duty	1.5	1321-3R8-B	1321-3RA8-B	1321-3R8-B	1321-3RA8-B
20AB6P8	Normal Duty	2	1321-3R8-B	1321-3RA8-B	1321-3R8-B	1321-3RA8-B
20AB9P6	Heavy Duty	2	1321-3R8-B	1321-3RA8-B	1321-3R12-B	1321-3RA12-B
20AB9P6	Normal Duty	3	1321-3R12-B	1321-3RA12-B	1321-3R12-B	1321-3RA12-B
20AB015	Heavy Duty	3	1321-3R12-B	1321-3RA12-B	1321-3R18-B	1321-3RA18-B
20AB015	Normal Duty	5	1321-3R18-B	1321-3RA18-B	1321-3R18-B	1321-3RA18-B
20AB022	Heavy Duty	5	1321-3R18-B	1321-3RA18-B	1321-3R25-B	1321-3RA25-B
20AB022	Normal Duty	7.5	1321-3R25-B	1321-3RA25-B	1321-3R25-B	1321-3RA25-B
20AB028	Heavy Duty	7.5	1321-3R25-B	1321-3RA25-B	1321-3R35-B	1321-3RA35-B
20AB028	Normal Duty	10	1321-3R35-B	1321-3RA35-B	1321-3R35-B	1321-3RA35-B
20AB042	Heavy Duty	10	1321-3R35-B	1321-3RA35-B	1321-3R45-B	1321-3RA45-B
20AB042	Normal Duty	15	1321-3R45-B	1321-3RA45-B	1321-3R45-B	1321-3RA45-B
20AB054	Heavy Duty	15	1321-3R45-B	1321-3RA45-B	1321-3R55-B	1321-3RA55-B
20AB054	Normal Duty	20	1321-3R55-B	1321-3RA55-B	1321-3R55-B	1321-3RA55-B
20AB070	Heavy Duty	20	1321-3R55-B	1321-3RA55-B	1321-3R80-B	1321-3RA80-B
20AB070	Normal Duty	25	1321-3R80-B	1321-3RA80-B	1321-3R80-B	1321-3RA80-B

(1) Input line reactors were sized based on the NEC fundamental motor amps. Output line reactors were sized based on the VFD rated output currents.

Table 3 - 480V, 60 Hz, Three-phase, 3% Impedance

Drive Cat. No.	Duty	Hp	Input Line Reactor ⁽¹⁾		Output Line Reactor ⁽¹⁾	
			IP00 (NEMA/UL Type Open)	IP11 (NEMA/UL Type 1)	IP00 (NEMA/UL Type Open)	IP11 (NEMA/UL Type 1)
			Cat. No.	Cat. No.	Cat. No.	Cat. No.
20AD1P1	Heavy Duty	0.33	1321-3R1-C	1321-3RA1-C	1321-3R2-B	1321-3RA2-B
20AD1P1	Normal Duty	0.5	1321-3R1-C	1321-3RA1-C	1321-3R2-B	1321-3RA2-B
20AD2P1	Heavy Duty	0.75	1321-3R2-A	1321-3RA2-A	1321-3R2-A	1321-3RA2-A
20AD2P1	Normal Duty	1	1321-3R2-A	1321-3RA2-A	1321-3R2-A	1321-3RA2-A
20AD3P4	Heavy Duty	1.5	1321-3R4-C	1321-3RA4-C	1321-3R4-B	1321-3RA4-B
20AD3P4	Normal Duty	2	1321-3R4-B	1321-3RA4-B	1321-3R4-B	1321-3RA4-B
20AD5P0	Heavy Duty	2	1321-3R4-B	1321-3RA4-B	1321-3R8-C	1321-3RA8-C
20AD5P0	Normal Duty	3	1321-3R8-C	1321-3RA8-C	1321-3R8-C	1321-3RA8-C
20AD8P0	Heavy Duty	3	1321-3R8-C	1321-3RA8-C	1321-3R8-B	1321-3RA8-B
20AD8P0	Normal Duty	5	1321-3R8-B	1321-3RA8-B	1321-3R8-B	1321-3RA8-B
20AD011	Heavy Duty	5	1321-3R8-B	1321-3RA8-B	1321-3R12-B	1321-3RA12-B
20AD011	Normal Duty	7.5	1321-3R12-B	1321-3RA12-B	1321-3R12-B	1321-3RA12-B
20AD014	Heavy Duty	7.5	1321-3R12-B	1321-3RA12-B	1321-3R18-B	1321-3RA18-B
20AD014	Normal Duty	10	1321-3R18-B	1321-3RA18-B	1321-3R18-B	1321-3RA18-B
20AD022	Heavy Duty	10	1321-3R18-B	1321-3RA18-B	1321-3R25-B	1321-3RA25-B
20AD022	Normal Duty	15	1321-3R25-B	1321-3RA25-B	1321-3R25-B	1321-3RA25-B
20AD027	Heavy Duty	15	1321-3R25-B	1321-3RA25-B	1321-3R25-B	1321-3RA25-B
20AD027	Normal Duty	20	1321-3R35-B	1321-3RA35-B	1321-3R25-B	1321-3RA25-B
20AD034	Heavy Duty	20	1321-3R35-B	1321-3RA35-B	1321-3R35-B	1321-3RA35-B
20AD034	Normal Duty	25	1321-3R35-B	1321-3RA35-B	1321-3R35-B	1321-3RA35-B
20AD040	Heavy Duty	25	1321-3R35-B	1321-3RA35-B	1321-3R45-B	1321-3RA45-B
20AD040	Normal Duty	30	1321-3R45-B	1321-3RA45-B	1321-3R45-B	1321-3RA45-B
20AD052	Heavy Duty	30	1321-3R45-B	1321-3RA45-B	1321-3R55-B	1321-3RA55-B
20AD052	Normal Duty	40	1321-3R55-B	1321-3RA55-B	1321-3R55-B	1321-3RA55-B
20AD065	Heavy Duty	40	1321-3R55-B	1321-3RA55-B	1321-3R80-B	1321-3RA80-B
20AD065	Normal Duty	50	1321-3R80-B	1321-3RA80-B	1321-3R80-B	1321-3RA80-B

(1) Input line reactors were sized based on the NEC fundamental motor amps. Output line reactors were sized based on the VFD rated output currents.

Table 4 - 480V, 60 Hz, Three-phase, 5% Impedance

Drive Cat. No.	Duty	Hp	Input Line Reactor ⁽¹⁾		Output Line Reactor ⁽¹⁾	
			IP00 (NEMA/UL Type Open)	IP11 (NEMA/UL Type 1)	IP00 (NEMA/UL Type Open)	IP11 (NEMA/UL Type 1)
			Cat. No.	Cat. No.	Cat. No.	Cat. No.
20AD1P1	Heavy Duty	0.33	1321-3R1-B	1321-3RA1-B	1321-3R2-C	1321-3RA2-C
20AD1P1	Normal Duty	0.5	1321-3R1-B	1321-3RA1-B	1321-3R2-C	1321-3RA2-C
20AD2P1	Heavy Duty	0.75	1321-3R2-C	1321-3RA2-C	1321-3R2-B	1321-3RA2-B
20AD2P1	Normal Duty	1	1321-3R2-B	1321-3RA2-B	1321-3R2-B	1321-3RA2-B
20AD3P4	Heavy Duty	1.5	1321-3R4-D	1321-3RA4-D	1321-3R4-D	1321-3RA4-D
20AD3P4	Normal Duty	2	1321-3R4-D	1321-3RA4-D	1321-3R4-D	1321-3RA4-D
20AD5P0	Heavy Duty	2	1321-3R4-D	1321-3RA4-D	1321-3R8-D	1321-3RA8-D
20AD5P0	Normal Duty	3	1321-3R8-D	1321-3RA8-D	1321-3R8-D	1321-3RA8-D
20AD8P0	Heavy Duty	3	1321-3R8-D	1321-3RA8-D	1321-3R8-C	1321-3RA8-C
20AD8P0	Normal Duty	5	1321-3R8-C	1321-3RA8-C	1321-3R8-C	1321-3RA8-C
20AD011	Heavy Duty	5	1321-3R8-C	1321-3RA8-C	1321-3R12-C	1321-3RA12-C
20AD011	Normal Duty	7.5	1321-3R12-C	1321-3RA12-C	1321-3R12-C	1321-3RA12-C
20AD014	Heavy Duty	7.5	1321-3R12-C	1321-3RA12-C	1321-3R18-C	1321-3RA18-C
20AD014	Normal Duty	10	1321-3R18-C	1321-3RA18-C	1321-3R18-C	1321-3RA18-C
20AD022	Heavy Duty	10	1321-3R18-C	1321-3RA18-C	1321-3R25-C	1321-3RA25-C
20AD022	Normal Duty	15	1321-3R25-C	1321-3RA25-C	1321-3R25-C	1321-3RA25-C
20AD027	Heavy Duty	15	1321-3R25-C	1321-3RA25-C	1321-3R25-C	1321-3RA25-C
20AD027	Normal Duty	20	1321-3R35-C ⁽²⁾	1321-3RA35-C ⁽²⁾	1321-3R25-C	1321-3RA25-C
20AD034	Heavy Duty	20	1321-3R35-C ⁽²⁾	1321-3RA35-C ⁽²⁾	1321-3R35-C	1321-3RA35-C
20AD034	Normal Duty	25	1321-3R35-C	1321-3RA35-C	1321-3R35-C	1321-3RA35-C
20AD040	Heavy Duty	25	1321-3R35-C	1321-3RA35-C	1321-3R45-C	1321-3RA45-C
20AD040	Normal Duty	30	1321-3R45-C	1321-3RA45-C	1321-3R45-C	1321-3RA45-C
20AD052	Heavy Duty	30	1321-3R45-C	1321-3RA45-C	1321-3R55-C	1321-3RA55-C
20AD052	Normal Duty	40	1321-3R55-C	1321-3RA55-C	1321-3R55-C	1321-3RA55-C
20AD065	Heavy Duty	40	1321-3R55-C	1321-3RA55-C	1321-3R80-C	1321-3RA80-C
20AD065	Normal Duty	50	1321-3R80-C	1321-3RA80-C	1321-3R80-C	1321-3RA80-C

(1) Input line reactors were sized based on the NEC fundamental motor amps. Output line reactors were sized based on the VFD rated output currents.

(2) 4% impedance.

Table 5 - 600V, 60 Hz, Three-phase, 3% Impedance

Drive Cat. No.	Duty	Hp	Input Line Reactor ⁽¹⁾		Output Line Reactor ⁽¹⁾	
			IP00 (NEMA/UL Type Open)	IP11 (NEMA/UL Type 1)	IP00 (NEMA/UL Type Open)	IP11 (NEMA/UL Type 1)
			Cat. No.	Cat. No.	Cat. No.	Cat. No.
20AE0P9	Heavy Duty	0.33	1321-3R1-C	1321-3RA1-C	1321-3R1-B	1321-3RA1-B
20AE0P9	Normal Duty	0.5	1321-3R1-C	1321-3RA1-C	1321-3R1-B	1321-3RA1-B
20AE1P7	Heavy Duty	0.75	1321-3R2-B	1321-3RA2-B	1321-3R2-B	1321-3RA2-B
20AE1P7	Normal Duty	1	1321-3R2-B	1321-3RA2-B	1321-3R2-B	1321-3RA2-B
20AE2P7	Heavy Duty	1.5	1321-3R2-A	1321-3RA2-A	1321-3R4-D	1321-3RA4-D
20AE2P7	Normal Duty	2	1321-3R4-C	1321-3RA4-C	1321-3R4-D	1321-3RA4-D
20AE3P9	Heavy Duty	2	1321-3R4-C	1321-3RA4-C	1321-3R4-C	1321-3RA4-C
20AE3P9	Normal Duty	3	1321-3R4-C	1321-3RA4-C	1321-3R4-C	1321-3RA4-C
20AE6P1	Heavy Duty	3	1321-3R4-C	1321-3RA4-C	1321-3R8-C	1321-3RA8-C
20AE6P1	Normal Duty	5	1321-3R8-C	1321-3RA8-C	1321-3R8-C	1321-3RA8-C
20AE9P0	Heavy Duty	5	1321-3R8-C	1321-3RA8-C	1321-3R12-C	1321-3RA12-C
20AE9P0	Normal Duty	7.5	1321-3R12-C	1321-3RA12-C	1321-3R12-C	1321-3RA12-C
20AE011	Heavy Duty	7.5	1321-3R12-C	1321-3RA12-C	1321-3R12-B	1321-3RA12-B
20AE011	Normal Duty	10	1321-3R12-B	1321-3RA12-B	1321-3R12-B	1321-3RA12-B
20AE017	Heavy Duty	10	1321-3R12-B	1321-3RA12-B	1321-3R18-B	1321-3RA18-B
20AE017	Normal Duty	15	1321-3R18-B	1321-3RA18-B	1321-3R18-B	1321-3RA18-B
20AE022	Heavy Duty	15	1321-3R18-B	1321-3RA18-B	1321-3R25-B	1321-3RA25-B
20AE022	Normal Duty	20	1321-3R25-B	1321-3RA25-B	1321-3R25-B	1321-3RA25-B
20AE027	Heavy Duty	20	1321-3R25-B	1321-3RA25-B	1321-3R35-C	1321-3RA35-C
20AE027	Normal Duty	25	1321-3R35-C	1321-3RA35-C	1321-3R35-C	1321-3RA35-C
20AE032	Heavy Duty	25	1321-3R35-C	1321-3RA35-C	1321-3R35-B	1321-3RA35-B
20AE032	Normal Duty	30	1321-3R35-B	1321-3RA35-B	1321-3R35-B	1321-3RA35-B
20AE041	Heavy Duty	30	1321-3R35-B	1321-3RA35-B	1321-3R45-B	1321-3RA45-B
20AE041	Normal Duty	40	1321-3R45-B	1321-3RA45-B	1321-3R45-B	1321-3RA45-B
20AE052	Heavy Duty	40	1321-3R45-B	1321-3RA45-B	1321-3R55-B	1321-3RA55-B
20AE052	Normal Duty	50	1321-3R55-B	1321-3RA55-B	1321-3R55-B	1321-3RA55-B

(1) Input line reactors were sized based on the NEC fundamental motor amps. Output line reactors were sized based on the VFD rated output currents.

Table 6 - 600V, 60 Hz, Three-phase, 5% Impedance

Drive Cat. No.	Duty	Hp	Input Line Reactor ⁽¹⁾		Output Line Reactor ⁽¹⁾	
			IP00 (NEMA/UL Type Open)	IP11 (NEMA/UL Type 1)	IP00 (NEMA/UL Type Open)	IP11 (NEMA/UL Type 1)
			Cat. No.	Cat. No.	Cat. No.	Cat. No.
20AE0P9	Heavy Duty	0.33	1321-3R1-A	1321-3RA1-A	1321-3R1-B	1321-3RA1-B
20AE0P9	Normal Duty	0.5	1321-3R1-B	1321-3RA1-B	1321-3R1-B	1321-3RA1-B
20AE1P7	Heavy Duty	0.5	1321-3R1-B	1321-3RA1-B	1321-3R2-C	1321-3RA2-C
20AE1P7	Normal Duty	1	1321-3R2-C	1321-3RA2-C	1321-3R2-C	1321-3RA2-C
20AE2P7	Heavy Duty	1	1321-3R2-C	1321-3RA2-C	1321-3R4-D ⁽²⁾	1321-3RA4-D ⁽²⁾
20AE2P7	Normal Duty	2	1321-3R4-D ⁽²⁾	1321-3RA4-D ⁽²⁾	1321-3R4-D ⁽²⁾	1321-3RA4-D ⁽²⁾
20AE3P9	Heavy Duty	2	1321-3R4-D ⁽²⁾	1321-3RA4-D ⁽²⁾	1321-3R4-D	1321-3RA4-D
20AE3P9	Normal Duty	3	1321-3R4-D	1321-3RA4-D	1321-3R4-D	1321-3RA4-D
20AE6P1	Heavy Duty	3	1321-3R4-D	1321-3RA4-D	1321-3R8-D	1321-3RA8-D
20AE6P1	Normal Duty	5	1321-3R8-D	1321-3RA8-D	1321-3R8-D	1321-3RA8-D
20AE9P0	Heavy Duty	5	1321-3R8-D	1321-3RA8-D	1321-3R12-C ⁽²⁾	1321-3RA12-C ⁽²⁾
20AE9P0	Normal Duty	7.5	1321-3R12-C ⁽²⁾	1321-3RA12-C ⁽²⁾	1321-3R12-C ⁽²⁾	1321-3RA12-C ⁽²⁾
20AE011	Heavy Duty	7.5	1321-3R12-C ⁽²⁾	1321-3RA12-C ⁽²⁾	1321-3R12-C	1321-3RA12-C
20AE011	Normal Duty	10	1321-3R12-C	1321-3RA12-C	1321-3R12-C	1321-3RA12-C
20AE017	Heavy Duty	10	1321-3R12-C	1321-3RA12-C	1321-3R18-C	1321-3RA18-C
20AE017	Normal Duty	15	1321-3R18-C	1321-3RA18-C	1321-3R18-C	1321-3RA18-C
20AE022	Heavy Duty	15	1321-3R18-C	1321-3RA18-C	1321-3R25-C ⁽²⁾	1321-3RA25-C ⁽²⁾
20AE022	Normal Duty	20	1321-3R25-C ⁽²⁾	1321-3RA25-C ⁽²⁾	1321-3R25-C ⁽²⁾	1321-3RA25-C ⁽²⁾
20AE027	Heavy Duty	20	1321-3R25-C ⁽²⁾	1321-3RA25-C ⁽²⁾	1321-3R35-C ⁽²⁾	1321-3RA35-C ⁽²⁾
20AE027	Normal Duty	25	1321-3R35-C ⁽²⁾	1321-3RA35-C ⁽²⁾	1321-3R35-C ⁽²⁾	1321-3RA35-C ⁽²⁾
20AE032	Heavy Duty	25	1321-3R35-C ⁽²⁾	1321-3RA35-C ⁽²⁾	1321-3R35-C ⁽²⁾	1321-3RA35-C ⁽²⁾
20AE032	Normal Duty	30	1321-3R35-C ⁽²⁾	1321-3RA35-C ⁽²⁾	1321-3R35-C ⁽²⁾	1321-3RA35-C ⁽²⁾
20AE041	Heavy Duty	30	1321-3R35-C ⁽²⁾	1321-3RA35-C ⁽²⁾	1321-3R45-C	1321-3RA45-C
20AE041	Normal Duty	40	1321-3R45-C	1321-3RA45-C	1321-3R45-C	1321-3RA45-C
20AE052	Heavy Duty	40	1321-3R45-C	1321-3RA45-C	1321-3R55-C	1321-3RA55-C
20AE052	Normal Duty	50	1321-3R55-C	1321-3RA55-C	1321-3R55-C	1321-3RA55-C

(1) Input line reactors were sized based on the NEC fundamental motor amps. Output line reactors were sized based on the VFD rated output currents.

(2) 4% impedance.

Installation Considerations

Power Wiring

The PowerFlex 70 has the following built in protective features to help simplify installation:

- Ground fault protection during start-up and running helps ensure reliability
- Electronic motor overload protection increases motor life
- Removable MOV to ground and common mode capacitors to ground ensure compatibility with ungrounded systems. These devices must be disconnected if the drive is installed on an ungrounded, high-resistance or B phase grounded distribution system. These devices must also be disconnected if a regenerative unit is used as a bus supply or brake.
- 6kV transient protection increased robustness for 380...480V system voltages

There are many other factors that must be considered for optimal performance in any given application. The block diagram below highlights the primary installation considerations. Consult Wiring and Grounding Guidelines for Pulse Width Modulated (PWM) AC Drives, publication [DRIVES-IN001](#), for detailed recommendations on input power conditioning, dynamic braking, reflected wave protection, and motor cables types.

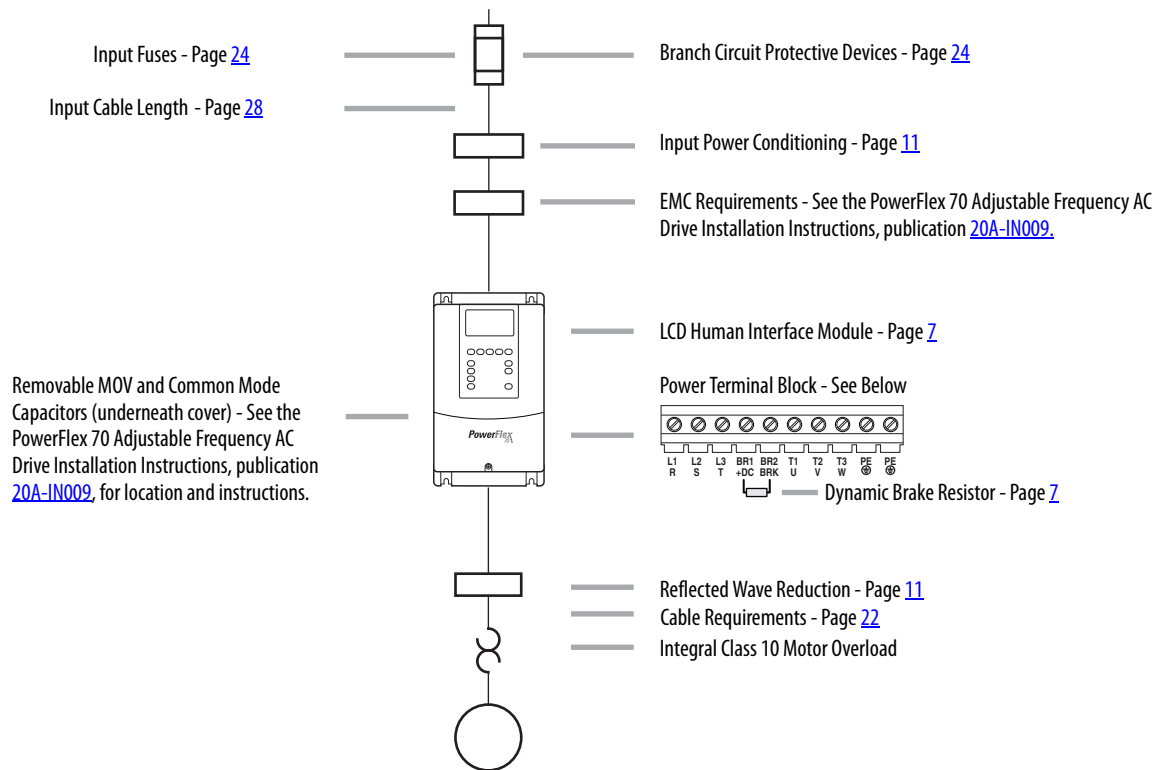

Terminal Blocks

Terminal Block Specifications

No.	Name	Description	Frame	Wire Size Range ⁽¹⁾		Torque	
				Max, mm ² (AWG)	Min, mm ² (AWG)	Max, N•m (lb•in)	Recommended, N•m (lb•in)
❶	I/O terminal block	Signal and control connections	All	1.5 (16)	0.05 (30)	0.55 (4.9)	0.5 (4.4)
❷	Power terminal block	Input power and motor connections	A, B, and C	3.5 (12)	0.3 (22)	0.66 (5.5)	0.6 (5)
			D	8.4 (8)	0.8 (18)	1.7 (15)	1.4 (12)
			E	25.0 (3)	2.5 (14)	2.71 (24)	2.71 (24)
❸	SHLD terminal	Terminating point for wiring shields	All	—	—	1.6 (14)	1.6 (14)

(1) Maximum/minimum sizes that the terminal block accepts - these are not recommendations.

Terminal	Description	Notes
BR1	DC brake (+)	DB resistor connection - Important: Do not connect both an internal and external DB resistor at the same time. This can violate the minimum allowed DB resistance and cause drive damage.
BR2	DC brake (-)	
+DC	DC bus (+)	❹ Test point on Frames A...D on the left or right of the power terminal block. Frame E has a dedicated terminal.
-DC	DC bus (-)	
PE	PE ground	
U, V, W	U (T1), V (T2), W (T3)	To the motor
R, S, T	R (L1), S (L2), T (L3)	AC line input power

Typical Terminal Block Location

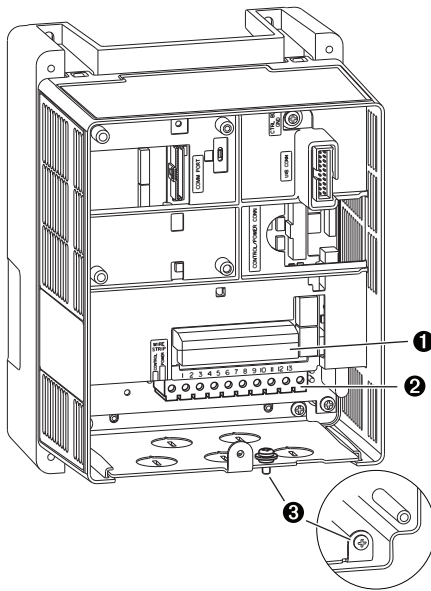

Power Terminals

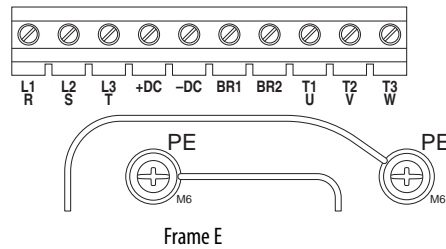
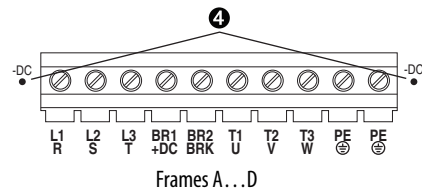

Control Terminals

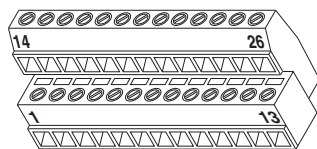

No.	Signal	Factory Default	Description	Related Param.
1	Digital In 1	Stop – CF (CF = clear fault)	11.2 mA at 24V DC	361...366
2	Digital In 2	Start	19.2V minimum on state	
3	Digital In 3	Auto/Man	3.2V maximum off state	
4	Digital In 4	Speed Sel 1	Important: Use only 24V DC, not suitable for 115V AC circuitry. ⁽³⁾	
5	Digital In 5	Speed Sel 2	Inputs can be wired as sink or source.	
6	Digital In 6	Speed Sel 3		
7	24V Common	–	Drive supplied power for digital In1...6 inputs only.	
8	Digital In Common	–	Not intended for use on circuits outside of the drive.	
9	+24V DC	–	See examples beginning on page 21 . 150 mA maximum load.	
10	+10V Pot Reference	–	2 k Ω minimum load.	
11	Digital Out 1 – N.O. ⁽¹⁾	NOT Fault	<u>Max Resistive Load</u> 250V AC / 30V DC 50 VA / 60 Watts	380...387
12	Digital Out 1 Common		<u>Max Inductive Load</u> 250V AC / 30V DC 25 VA / 30 Watts	
13	Digital Out 1 – N.C. ⁽¹⁾	Fault	<u>Minimum DC Load</u> 10 μ A, 10 mV DC	
14	Analog In 1 (– Volts)	⁽²⁾ Voltage – Reads value at 14 & 15	Non-isolated, 0...10V, 10 bit, 100 k Ω input impedance. ⁽⁴⁾	320...327
15	Analog In 1 (+ Volts)		Non-isolated, 4...20 mA, 10 bit, 100 Ω input impedance. ⁽⁴⁾	
16	Analog In 1 (– Current)	⁽²⁾ Voltage – Reads value at 18 & 19	Isolated, bipolar, differential, 0...10V unipolar (10 bit) or \pm 10V bipolar (10 bit and sign), 100 k Ω input impedance. ⁽⁵⁾	
17	Analog In 1 (+ Current)		Isolated, 4...20mA, 10 bit and sign, 100 Ω input impedance. ⁽⁵⁾	
18	Analog In 2 (– Volts)			
19	Analog In 2 (+ Volts)			340...344
20	Analog In 2 (– Current)	⁽²⁾ Output Freq	0...10V, 10 bit, 10 k Ω (2 k Ω minimum) load.	
21	Analog In 2 (+ Current)		0...20 mA, 10 bit, 400 Ω maximum load. ⁽⁶⁾	
22	10V Pot Common Analog Out (– Volts) Analog Out (– Current)		Referenced to chassis ground. Common if internal 10V supply (terminal 10) is used.	
23	Analog Out (+ Volts) Analog Out (+ Current)			
24	Digital Out 2 – N.O. ⁽¹⁾	Run	See description at No.s 11-13.	380...387
25	Digital Out 2 Common			
26	Digital Out 2 – N.C. ⁽¹⁾	NOT Run		

(1) Contacts shown in unpowered state. Any relay programmed as Fault or Alarm is energized (pick up) when power is applied to drive and deenergize (drop out) when fault or alarm exists. Relays selected for other functions are energized only when that condition exists and are deenergize when condition is removed.

(2) These inputs/outputs are dependent on a number of parameters. See “Related Parameters.”

(3) For use with 115V AC circuitry. A 115V AC interface option (AK-M9-115VAC-1) must be used

(4) Differential isolation - external source must be less than 10V with respect to PE.

(5) Differential isolation - external source must be maintained at less than 160V with respect to PE. Input provides high common mode immunity.

(6) Analog output current is only available with enhanced control drives.

Hardware Enable Circuitry (enhanced control only)

By default, you can program a digital input as an enable input. The status of this input is interpreted by drive software. If the application requires the drive to be disabled without software interpretation, a hardware enable configuration can be utilized. This is done by removing the enable jumper (ENBL JMP) and wiring the enable input to Digital In 6.

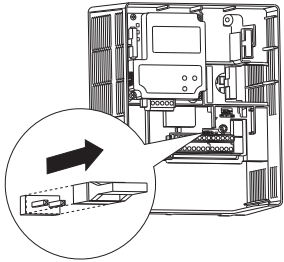

1. Remove drive cover.
2. Locate and remove the enable jumper on the main control board.
3. Wire the enable input to Digital In 6.
4. Verify that 366 [Digital In6 Sel] is set to option 1 Enable.

Safe Off Board Terminal Block (enhanced control only)

No.	Signal	Description
1	Monitor - N.C.	Normally closed contacts for monitoring relay status.
2	Common - N.C.	Maximum resistive load: 250V ac / 30V dc / 50 VA / 60 Watts Maximum inductive load: 250V ac / 30V dc / 25 VA / 30 Watts
3	+24V DC	Connections for user supplied power to energize coil.
4	24V common	

Connection Examples

For detailed connection examples refer to the DriveGuard Safe Torque Off Option (Series B) for PowerFlex 40P and PowerFlex 70 Enhanced Control AC Drives User Manual, publication [PFLEX-UM003](#).

Encoder Interface Terminal Block (enhanced control only)

No.	Signal	Description	Jumper Settings
1	5...12V power ⁽¹⁾	Internal power source 250 mA (isolated)	
2	Power return		
3	Encoder B (NOT)	Single channel or quadrature B input.	
4	Encoder B		
5	Encoder A (NOT)	Single channel or quadrature A input.	
6	Encoder A		

(1) Jumper selectable +5...12V is available on 20A-ENC-1 encoder boards.

Sample Encoder Wiring

I/O	Connection Example	I/O	Connection Example
Encoder Power – Internal Drive Power Internal (drive) 12V DC, 250mA		Encoder Power – External Power Source	
Encoder Signal – Single-Ended, Dual Channel		Encoder Signal – Differential, Dual Channel	

EMC Filters

Description	Frame	Factory Installed (Position 13)
Internal 3-phase 200...480 filter ❶	B, C, D	A

❶ Standard on Frames C and D. Optional on Frame B (Frame A ratings increase to Frame B).

Other Options

Description	Catalog No.	Factory Installed	
		User Installed (Position 15)	(Position 16)
Service connection board ❷	SK-M9-SCB1	N/A	N/A
115 V AC interface card	AK-M9-115VAC-1	N/A	N/A
Frame E flange gasket	AK-M9-GASKET1-E4	N/A	N/A

❷ Provides temporary DPI/HIM connection for NEMA 1 and flange drives with cover removed.

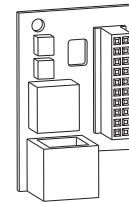

Service Connection Board
SK-M9-SCB1

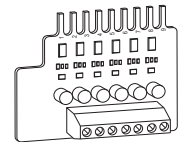

115V Interface Card
AK-M9-115VAC-1

I/O Wiring Examples

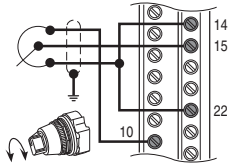
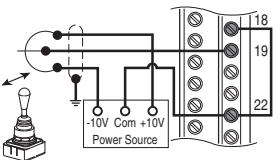
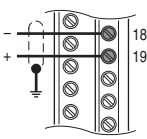
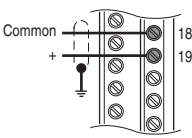
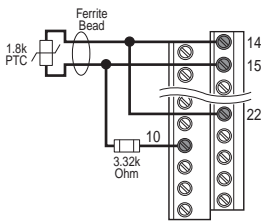
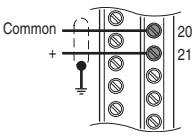
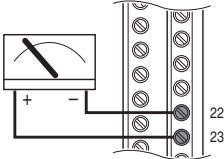
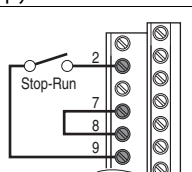
Input/Output	Connection Example	Required Parameter Settings
Potentiometer Unipolar Speed Reference 10 k Ω Pot. Recommended (2 k Ω minimum)		Select Speed Reference source: Param. 090 = 1 "Analog In 1" Adjust Scaling: Param. 091, 092, 322, 323 Check Results: Param. 016
Joystick Bipolar Speed Reference $\pm 10V$ Input		Set Direction Mode: Param. 190 = 1 "Bipolar" Adjust Scaling: Param. 091, 092, 325, 326 Check Results: Param. 017
Analog Input Bipolar Speed Reference $\pm 10V$ Input		Adjust Scaling: Param. 091, 092, 325, 326 Check Results: Param. 017
Analog Input Unipolar Speed Reference 0 to +10V Input		Adjust Scaling: Param. 091, 092, 325, 326 Check Results: Param. 017
Analog Input, PTC PTC OT set > 5V PTC OT cleared < 4V PTC Short < 0.2V		Set Fault Config 1: Param. 238, Bit #7 = 1 "Enabled" Set Alarm Config 1: Param. 259, Bit #11 = 1 "Enabled"
Analog Input Unipolar Speed Reference 4-20 mA Input		Configure Input for Current: Param. 320, Bit #1 = 1 "Current" Adjust Scaling: Param. 091, 092, 325, 326 Check Results: Param. 017
Analog Output Unipolar 0 to +10V Output. Can Drive a 2 k Ω load (25 mA short circuit limit)		Select Source Value: Param. 342 Adjust Scaling: Param. 343, 344
2 Wire Control Non-Reversing	Internal Supply 	Disable Digital Input 1: Param. 361 = 0 "Not Used" Set Digital Input 2: Param. 362 = 7 "Run"

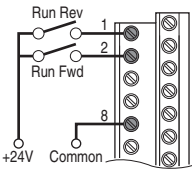
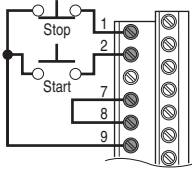
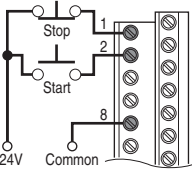
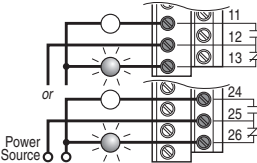
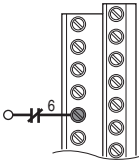
Input/Output	Connection Example	Required Parameter Settings
2 Wire Control Reversing	<p>External Supply</p> 	<p>Set Digital Input 1: Param. 361 = 8 "Run Forward"</p> <p>Set Digital Input 2: Param. 362 = 9 "Run Reverse"</p>
3 Wire Control	<p>Internal Supply</p> 	<p>Use factory default parameter settings.</p>
3 Wire Control	<p>External Supply</p> 	<p>Use factory default parameter settings.</p>
Digital Output Form C Relays Energized in Normal State.		<p>Select Source: Param. 380, 384</p>
Enable Input Shown in enabled state.		<p>Standard Control Configure with parameter 366</p> <p>Enhanced Control Configure with parameter 366</p> <p>For dedicated hardware Enable: Remove Enable Jumper (ENBL JMP) on the Main Control Board.</p>

Cable Recommendations

Cable Types Acceptable for 200...600V Installations

A variety of cable types are acceptable for drive installations. For many installations, unshielded cable is adequate, provided it can be separated from sensitive circuits. As an approximate guide, allow a spacing of 0.3 m (1 ft) for every 10 m (32.8 ft) of length. In all cases, long parallel runs must be avoided. Do not use cable with an insulation thickness less than or equal to 15 mils (0.4mm/0.015 in.). Use copper wire only. Wire gauge requirements and recommendations are based on 75 °C (167 °F). Do not reduce wire gauge when using higher temperature wire. See [Table 7 on page 23](#).

Unshielded

THHN, THWN, or similar wire is acceptable for drive installation in dry environments provided adequate free air space and/or conduit fill rates limits are provided. **Do not use THHN or similarly coated wire in wet areas.** Any wire chosen must have a minimum insulation thickness of 15 Mils and cannot have large variations in insulation concentricity.

Shielded/Armored Cable

Shielded cable contains all of the general benefits of multi-conductor cable with the added benefit of a copper braided shield that can contain much of the noise generated by a typical AC drive. Use shielded cable in installations with sensitive equipment such as weigh scales, capacitive proximity switches and other devices that can be affected by electrical noise in the distribution system. Applications with large numbers of drives in a similar location, imposed EMC regulations or a high degree of communications/ networking are also good candidates for shielded cable.

Shielded cable can also help reduce shaft voltage and induced bearing currents for some applications. In addition, the increased impedance of shielded cable can help extend the distance that the motor can be installed away from the drive without the addition of motor protective devices such as terminator networks. Refer to Reflected Wave in Wiring and Grounding Guidelines for Pulse Width Modulated (PWM) AC Drives, publication [DRIVES-IN001](#).

Follow all best practices required for the installation environment, including temperature, flexibility, moisture characteristics, and chemical resistance. In addition, use a braided shield that is specified by the cable manufacturer as having coverage of at least 75%. An additional foil shield can greatly improve noise containment.

A good example of recommended cable is Belden 295xx (xx determines gauge). This cable has four XLPE insulated conductors with a 100% coverage foil and an 85% coverage copper braided shield (with drain wire) surrounded by a PVC jacket.

Other types of shielded cable are available, but the selection of these types can limit the allowable cable length. Particularly, some of the newer cables bundle four conductors of THHN wire and wrap them tightly with a foil shield. This construction can greatly increase the cable charging current required and reduce the overall drive performance. Unless specified in the individual distance tables as tested with the drive, these cables are not recommended and their performance against the lead length limits supplied is not known.

Table 7 - Cable Type Recommendations

Location	Rating/Type	Description
Standard (Option 1)	600V, 90° C (194° F) XHHW2/RHW-2 Anixter B209500-B209507, Belden 29501-29507, or equivalent	<ul style="list-style-type: none"> • Four tinned copper conductors with XLP insulation. • Copper braid/aluminum foil combination shield and tinned copper drain wire. • PVC jacket.
Standard (Option 2)	Tray rated 600V, 90° C (194° F) RHH/RHW-2 Anixter OLF-7xxxx or equivalent	<ul style="list-style-type: none"> • Three tinned copper conductors with XLPE insulation. • 5 mil single helical copper tape (25% overlap min.) with three bare copper grounds in contact with shield. • PVC jacket.
Class I & II; Division I & II	Tray rated 600V, 90° C (194° F) RHH/RHW-2 Anixter 7V-7xxxx-3G or equivalent	<ul style="list-style-type: none"> • Three bare copper conductors with XLPE insulation and impervious corrugated continuously welded aluminum armor. • Black sunlight resistant PVC jacket overall. • Three copper grounds on #10 AWG and smaller.

Power Ratings and Branch Circuit Protection

See [Table 8](#) through [Table 13](#) for power ratings and branch circuit protection information.

Single-phase Input Power

The PowerFlex 70 drive is typically used with a three-phase input supply. Single-phase operation of the drive is not currently rated under the UL 508C listing. Rockwell Automation has verified that single-phase operation with output current derated by 50% of the three-phase ratings identified in [Table 11](#) through [Table 13](#).

Table 8 - 208/240 Volt AC Three-phase Input Drive Ratings and Input Protection Devices

Cat.No.	Frame ⁽¹⁾	Hp Rating		Input Ratings		Output Amps			Dual Element Time Delay Fuse		Non-time Delay Fuse		Circuit Breaker ⁽⁴⁾	Motor Circuit Protector ⁽⁶⁾	140M Motor Protector with Adjustable Current Range ^{(7) (8)}			
		ND	HD	Amps	kVA	Cont.	1 Min.	3 Sec.	Min ⁽²⁾	Max ⁽³⁾	Min ⁽²⁾	Max ⁽³⁾	Max ⁽⁵⁾	Max ⁽⁵⁾	Available Catalog Numbers ⁽⁹⁾			Minimum Enclosure Volume (in. ³) ⁽¹⁰⁾
208 Volt AC Input																		
20AB2P2	A	0.5	0.33	2.9	1.1	2.5	2.7	3.7	6	6	6	10	15	7	140M-C2E-B40	140M-D8E-B40	–	3441
20AB4P2	A	1	0.75	5.6	2	4.8	5.5	7.4	10	10	10	17.5	15	7	140M-C2E-B63	140M-D8E-B63	–	3441
20AB6P8	B	2	1.5	10	3.6	7.8	10.3	13.8	15	15	15	30	30	15	140M-C2E-C10	140M-D8E-C10	140M-F8E-C10	3441
20AB9P6	B	3	2	14	5.1	11	12.1	16.5	20	25	20	40	40	30	140M-C2E-C16	140M-D8E-C16	140M-F8E-C16	3441
20AB015	C	5	3	16	5.8	17.5	19.2	26.6	20	35	20	70	70	30	140M-C2E-C20	140M-D8E-C20	140M-F8E-C20	3441
20AB022	D	7.5	5	23.3	8.3	25.3	27.8	37.9	30	50	30	100	100	30	–	140M-D8E-C25	140M-F8E-C25	5098
20AB028	D	10	7.5	29.8	10.7	32.2	37.9	50.6	40	70	40	125	125	50	–	–	140M-F8E-C32	5098
20AB042	D	15	10	39.8	14.3	43	55.5	74	60	100	60	175	175	70	–	–	140M-F8E-C45	5098
20AB054	E	20	15	57.5	20.7	62.1	72.4	96.6	80	125	80	200	200	100	–	–	–	–
20AB070	E	25	20	72.3	26.0	78.2	93.1	124	90	175	90	300	300	100	–	–	–	–
240 Volt AC Input																		
20AB2P2	A	0.5	0.33	2.5	1.1	2.2	2.4	3.3	3	4.5	3	8	15	3	140M-C2E-B25	140M-D8E-B25	–	3441
20AB4P2	A	1	0.75	4.8	2	4.2	4.8	6.4	6	9	6	15	15	7	140M-C2E-B63	140M-D8E-B63	–	3441
20AB6P8	B	2	1.5	8.7	3.6	6.8	9	12	15	15	25	25	15	140M-C2E-C10	140M-D8E-C10	140M-F8E-C10	3441	
20AB9P6	B	3	2	12.2	5.1	9.6	10.6	14.4	20	20	20	35	35	15	140M-C2E-C16	140M-D8E-C16	140M-F8E-C16	3441
20AB015	C	5	3	13.9	5.8	15.3	17.4	23.2	20	30	20	60	60	30	140M-C2E-C16	140M-D8E-C16	140M-F8E-C16	3441
20AB022	D	7.5	5	19.9	8.3	22	24.4	33	25	45	25	80	80	30	–	140M-D8E-C25	140M-F8E-C25	5098
20AB028	D	10	7.5	25.7	10.7	28	33	44	35	60	35	110	110	50	–	–	140M-F8E-C32	5098
20AB042	D	15	10	38.7	16.1	42	46.2	63	50	90	50	150	150	50	–	–	140M-F8E-C45	5098
20AB054	E	20	15	49.8	20.7	54	63	84	60	100	60	200	200	100	–	–	–	–
20AB070	E	25	20	64.5	26.8	70	81	108	90	150	90	275	275	100	–	–	–	–

See [page 27](#) for notes.

Table 9 - 400/480 Volt AC Three-phase Input Drive Ratings and Input Protection Devices

Cat.No.	Frame ⁽¹⁾	Hp Rating		Input Ratings		Output Amps			Dual Element Time Delay Fuse		Non-time Delay Fuse		Circuit Breaker ⁽⁴⁾	Motor Circuit Protector ⁽⁶⁾	140M Motor Protector with Adjustable Current Range ^{(7) (8)}			
		ND	HD	Amps	kVA	Cont.	1 Min.	3 Sec.	Min ⁽²⁾	Max ⁽³⁾	Min ⁽²⁾	Max ⁽³⁾	Max ⁽⁵⁾	Max ⁽⁵⁾	Available Catalog Numbers ⁽⁹⁾			Minimum Enclosure Volume (in. ³) ⁽¹⁰⁾
400 Volt AC Input																		
20AC1P3	A	0.37	0.25	1.6	1.1	1.3	1.4	1.9	3	3	3	5	15	3	140M-C2E-B16	–	–	3441
20AC2P1	A	0.75	0.55	2.5	1.8	2.1	2.4	3.2	4	6	4	8	15	7	140M-C2E-B25	140M-D8E-B25	–	3441
20AC3P5	A	1.5	1.1	4.3	3	3.5	4.5	6	6	6	6	12	15	7	140M-C2E-B63	140M-D8E-B63	–	3441
20AC5P0	B	2.2	1.5	6.5	4.5	5	5.5	7.5	10	10	10	20	20	15	140M-C2E-C10	140M-D8E-C10	140M-F8E-C10	3441
20AC8P7	B	4	3	11.3	7.8	8.7	9.9	13.2	15	17.5	15	30	30	15	140M-C2E-C16	140M-D8E-C16	140M-F8E-C16	3441
20AC011	C	5.5	4	10.5	7.6	11.5	13	17.4	15	25	15	45	40	15	140M-C2E-C16	140M-D8E-C16	140M-F8E-C16	3441
20AC015	C	7.5	5.5	15.1	10.4	15.4	17.2	23.1	20	30	20	60	60	20	140M-C2E-C16	140M-D8E-C16	140M-F8E-C16	3441
20AC022	D	11	7.5	21.9	15.2	22	24.2	33	30	45	30	80	80	30	–	140M-D8E-C25	140M-F8E-C25	5098
20AC030	D	15	11	30.3	21	30	33	45	40	60	40	120	120	50	–	–	140M-F8E-C32	5098
20AC037	D	18.5	15	35	24.3	37	45	60	50	80	50	125	140	50	–	–	140M-F8E-C45	5098
20AC043	D	22	18.5	40.7	28.2	43	56	74	60	90	60	150	160	70	–	–	–	–
20AC060	E	30	22	56.8	39.3	60	66	90	80	125	80	225	240	80	–	–	–	–
20AC072	E	37	30	68.9	47.8	72	90	120	90	150	90	250	280	100	–	–	–	–
480 Volt AC Input																		
20AD1P1	A	0.5	0.33	1.3	1.1	1.2	1.6	3	3	3	4	15	3	140M-C2E-B16	–	–	3441	
20AD2P1	A	1	0.75	2.4	2	2.1	2.4	3.2	3	6	3	8	15	3	140M-C2E-B25	140M-D8E-B25	–	3441
20AD3P4	A	2	1.5	3.8	3.2	3.4	4.5	6	6	6	12	15	7	140M-C2E-B40	140M-D8E-B40	–	3441	
20AD5P0	B	3	2	5.6	4.7	5	5.5	7.5	10	10	10	20	20	15	140M-C2E-B63	140M-D8E-B63	–	3441
20AD8P0	B	5	3	9.8	8.4	8	8.8	12	15	15	30	30	15	140M-C2E-C10	140M-D8E-C10	140M-F8E-C10	3441	
20AD011	C	7.5	5	9.4	7.9	11	12.1	16.5	15	20	15	40	40	15	140M-C2E-C16	140M-D8E-C16	140M-F8E-C16	3441
20AD014	C	10	7.5	12.4	10.4	14	16.5	22	20	30	20	50	50	20	140M-C2E-C16	140M-D8E-C16	140M-F8E-C16	3441
20AD022	D	15	10	19.9	16.6	22	24.2	33	25	45	25	80	80	30	–	140M-D8E-C25	140M-F8E-C25	5098
20AD027	D	20	15	24.8	20.6	27	33	44	35	60	35	100	100	50	–	–	140M-F8E-C32	5098
20AD034	D	25	20	31.2	25.9	34	40.5	54	40	70	40	125	125	50	–	–	140M-F8E-C45	5098
20AD040	D	30	25	36.7	30.5	40	51	68	50	90	50	150	150	50	–	–	140M-F8E-C45	5098
20AD052	E	40	30	47.7	39.7	52	60	80	60	110	60	200	200	70	–	–	–	–
20AD065	E	50	40	59.6	49.6	65	78	104	80	125	80	250	250	100	–	–	–	–

See [page 27](#) for notes.**Table 10 - 600 Volt AC Three-phase Input Drive Ratings and Input Protection Devices**

Cat.No.	Frame ⁽¹⁾	Hp Rating		Input Ratings		Output Amps			Dual Element Time Delay Fuse		Non-time Delay Fuse		Circuit Breaker ⁽⁴⁾	Motor Circuit Protector ⁽⁶⁾	140M Motor Protector with Adjustable Current Range ^{(7) (8)}			
		ND	HD	Amps	kVA	Cont.	1 Min.	3 Sec.	Min ⁽²⁾	Max ⁽³⁾	Min ⁽²⁾	Max ⁽³⁾	Max ⁽⁵⁾	Max ⁽⁵⁾	Available Catalog Numbers ⁽⁹⁾			Minimum Enclosure Volume (in. ³) ⁽¹⁰⁾
600 Volt AC Input																		
20AE0P9	A	0.5	0.33	1.3	1.3	0.9	1.1	1.4	3	3	3	3.5	15	3	140M-C2E-B16	–	–	3441
20AE1P7	A	1	0.75	1.9	2	1.7	2	2.6	3	6	3	6	15	3	140M-C2E-B25	140M-D8E-B25	–	3441
20AE2P7	A	2	1.5	3	3.1	2.7	3.6	4.8	4	6	4	10	15	7	140M-C2E-B40	140M-D8E-B40	–	3441
20AE3P9	B	3	2	4.4	4.5	3.9	4.3	5.9	6	8	6	15	15	7	–	140M-D8E-B63	–	3441
20AE6P1	B	5	3	7.5	7.8	6.1	6.7	9.2	10	12	10	20	20	15	–	140M-D8E-C10	140M-F8E-C10	3441
20AE9P0	C	7.5	5	7.7	8	9	9.9	13.5	10	20	10	35	35	15	–	140M-D8E-C10	140M-F8E-C10	3441
20AE011	C	10	7.5	9.8	10.1	11	13.5	18	15	20	15	40	40	15	–	140M-D8E-C16	140M-F8E-C16	3441
20AE017	D	15	10	15.3	15.9	17	18.7	25.5	20	35	20	60	60	30	–	–	140M-F8E-C20	5098
20AE022	D	20	15	20	20.8	22	25.5	34	25	45	25	80	80	30	–	–	140M-F8E-C25	5098
20AE027	D	25	20	24.8	25.7	27	33	44	35	60	35	100	100	50	–	–	140M-F8E-C25	5098
20AE032	D	30	25	29.4	30.5	32	40.5	54	40	70	40	125	125	50	–	–	140M-F8E-C32	5098
20AE041	E	40	30	37.6	39.1	41	48	64	50	90	50	150	150	100	–	–	–	–
20AE052	E	50	40	47.7	49.6	52	61.5	82	60	110	60	200	200	100	–	–	–	–

See [page 27](#) for notes.

Table 11 - 208/240 Volt AC Single-phase Input Drive Ratings and Input Protection Devices

Cat.No.	Frame ⁽¹⁾	Hp Rating		Input Ratings		Output Amps			Dual Element Time Delay Fuse		Non-time Delay Fuse		Circuit Breaker ⁽⁴⁾	Motor Circuit Protector ⁽⁶⁾	140M Motor Protector with Adjustable Current Range ^{(7) (8)}			
		ND	HD	Amps	kVA	Cont.	1 Min.	3 Sec.	Min ⁽²⁾	Max ⁽³⁾	Min ⁽²⁾	Max ⁽³⁾	Max ⁽⁵⁾	Max ⁽⁵⁾	Available Catalog Numbers ⁽⁹⁾		Minimum Enclosure Volume (in. ³) ⁽¹⁰⁾	
208 Volt AC Input																		
20AB2P2	A	0.5	0.33	2.9	0.6	1.3	1.6	1.9	6	6	6	10	15	7	140M-C2E-B40	140M-D8E-B40	–	3441
20AB4P2	A	1	0.75	5.6	1	2.4	2.8	3.7	10	10	10	17.5	15	7	140M-C2E-B63	140M-D8E-B63	–	3441
20AB6P8	B	2	1.5	10	1.8	3.9	5.2	6.9	15	15	15	30	30	15	140M-C2E-C10	140M-D8E-C10	140M-F8E-C10	3441
20AB9P6	B	3	2	14	2.6	5.5	6.1	8.3	20	25	20	40	40	30	140M-C2E-C16	140M-D8E-C16	140M-F8E-C16	3441
20AB015	C	5	3	16	2.9	8.6	9.6	13.3	20	35	20	70	70	30	140M-C2E-C20	140M-D8E-C20	140M-F8E-C20	3441
20AB022	D	7.5	5	23.3	4.2	12.7	13.9	19.0	30	50	30	100	100	30	–	140M-D8E-C25	140M-F8E-C25	5098
20AB028	D	10	7.5	29.8	5.4	16.1	19	25.3	40	70	40	125	125	50	–	–	140M-F8E-C32	5098
20AB042	D	15	10	39.8	7.2	21.5	27.8	37	60	100	60	175	175	70	–	–	140M-F8E-C45	5098
20AB054	E	20	15	57.5	10.4	31.1	36.2	48.3	80	125	80	200	200	100	–	–	–	–
20AB070	E	25	20	72.3	13.0	39.1	46.6	62	90	175	90	300	300	100	–	–	–	–
240 Volt AC Input																		
20AB2P2	A	0.5	0.33	2.5	0.6	1.1	1.2	1.7	3	4.5	3	8	15	3	140M-C2E-B25	140M-D8E-B25	–	3441
20AB4P2	A	1	0.75	4.8	1	2.1	2.4	3.2	6	9	6	15	15	7	140M-C2E-B63	140M-D8E-B63	–	3441
20AB6P8	B	2	1.5	8.7	1.8	3.4	4.5	6	15	15	15	25	25	15	140M-C2E-C10	140M-D8E-C10	140M-F8E-C10	3441
20AB9P6	B	3	2	12.2	2.6	4.8	5.3	7.2	20	20	20	35	35	15	140M-C2E-C16	140M-D8E-C16	140M-F8E-C16	3441
20AB015	C	5	3	13.9	2.9	7.7	8.7	11.6	20	30	20	60	60	30	140M-C2E-C16	140M-D8E-C16	140M-F8E-C16	3441
20AB022	D	7.5	5	19.9	4.2	11	12.2	16.5	25	45	25	80	80	30	–	140M-D8E-C25	140M-F8E-C25	5098
20AB028	D	10	7.5	25.7	5.4	14	16.5	22	35	60	35	110	110	50	–	–	140M-F8E-C32	5098
20AB042	D	15	10	38.7	8.1	21	23.1	31.5	50	90	50	150	150	50	–	–	140M-F8E-C45	5098
20AB054	E	20	15	49.8	10.4	27	31.5	42	60	100	60	200	200	100	–	–	–	–
20AB070	E	25	20	64.5	13.4	35	40.5	54	90	150	90	275	275	100	–	–	–	–

See page 27 for notes.

Table 12 - 400/480 Volt AC Single-phase Input Drive Ratings and Input Protection Devices

Cat.No.	Frame ⁽¹⁾	Hp Rating		Input Ratings		Output Amps			Dual Element Time Delay Fuse		Non-time Delay Fuse		Circuit Breaker ⁽⁴⁾	Motor Circuit Protector ⁽⁶⁾	140M Motor Protector with Adjustable Current Range ^{(7) (8)}			
		ND	HD	Amps	kVA	Cont.	1 Min.	3 Sec.	Min ⁽²⁾	Max ⁽³⁾	Min ⁽²⁾	Max ⁽³⁾	Max ⁽⁵⁾	Max ⁽⁵⁾	Available Catalog Numbers ⁽⁹⁾		Minimum Enclosure Volume (in. ³) ⁽¹⁰⁾	
400 Volt AC Input																		
20AC1P3	A	0.37	0.25	1.6	0.6	0.7	0.7	1.0	3	3	3	5	15	3	140M-C2E-B16	–	–	3441
20AC2P1	A	0.75	0.55	2.5	0.9	1.1	1.2	1.6	4	6	4	8	15	7	140M-C2E-B25	140M-D8E-B25	–	3441
20AC3P5	A	1.5	1.1	4.3	1.5	1.8	2.3	3	6	6	6	12	15	7	140M-C2E-B63	140M-D8E-B63	–	3441
20AC5P0	B	2.2	1.5	6.5	2.3	2.5	2.8	3.8	10	10	10	20	20	15	140M-C2E-C10	140M-D8E-C10	140M-F8E-C10	3441
20AC8P7	B	4	3	11.3	3.9	4.4	5.0	6.6	15	17.5	15	30	30	15	140M-C2E-C16	140M-D8E-C16	140M-F8E-C16	3441
20AC011	C	5.5	4	11	3.8	5.8	6.5	8.7	15	25	15	45	40	15	140M-C2E-C16	140M-D8E-C16	140M-F8E-C16	3441
20AC015	C	7.5	5.5	15.1	5.2	7.7	8.6	11.6	20	30	20	60	60	20	140M-C2E-C16	140M-D8E-C16	140M-F8E-C16	3441
20AC022	D	11	7.5	21.9	7.6	11	12.1	16.5	30	45	30	80	80	30	–	140M-D8E-C25	140M-F8E-C25	5098
20AC030	D	15	11	30.3	10.5	15	16.5	22.5	40	60	40	120	120	50	–	–	140M-F8E-C32	5098
20AC037	D	18.5	15	35	12.2	18.5	22.5	30	50	80	50	125	140	50	–	–	140M-F8E-C45	5098
20AC043	D	22	18.5	40.7	14.1	21.5	28	37	60	90	60	150	160	70	–	–	–	–
20AC060	E	30	22	56.8	19.7	30	33	45	80	125	80	225	240	80	–	–	–	–
20AC072	E	37	30	68.9	23.9	36	45	60	90	150	90	250	280	100	–	–	–	–
480 Volt AC Input																		
20AD1P1	A	0.5	0.33	1.3	0.6	0.6	0.6	0.8	3	3	3	4	15	3	140M-C2E-B16	–	–	3441
20AD2P1	A	1	0.75	2.4	1	1.1	1.2	1.6	3	6	3	8	15	3	140M-C2E-B25	140M-D8E-B25	–	3441
20AD3P4	A	2	1.5	3.8	1.6	1.7	2.3	3	6	6	6	12	15	7	140M-C2E-B40	140M-D8E-B40	–	3441
20AD5P0	B	3	2	5.6	2.4	2.5	2.6	3.8	10	10	10	20	20	15	140M-C2E-B63	140M-D8E-B63	–	3441
20AD8P0	B	5	3	9.8	4.2	4	4.4	6	15	15	15	30	30	15	140M-C2E-C10	140M-D8E-C10	140M-F8E-C10	3441

Table 12 - 400/480 Volt AC Single-phase Input Drive Ratings and Input Protection Devices (continued)

Cat. No.	Frame (1)	Hp Rating		Input Ratings		Output Amps			Dual Element Time Delay Fuse		Non-time Delay Fuse		Circuit Breaker (4)	Motor Circuit Protector (6)	140M Motor Protector with Adjustable Current Range (7) (8)			
		ND	HD	Amps	kVA	Cont.	1 Min.	3 Sec.	Min (2)	Max (3)	Min (2)	Max (3)	Max (5)	Max (5)	Available Catalog Numbers (9)		Minimum Enclosure Volume (in. 3) (10)	
20AD011	C	7.5	5	9.5	4	5.5	6.1	8.3	15	20	15	40	40	15	140M-C2E-C16	140M-D8E-C16	140M-F8E-C16	3441
20AD014	C	10	7.5	12.5	5.2	7	8.3	11	20	30	20	50	50	20	140M-C2E-C16	140M-D8E-C16	140M-F8E-C16	3441
20AD022	D	15	10	19.9	8.3	11	12.1	16.5	25	45	25	80	80	30	–	140M-D8E-C25	140M-F8E-C25	5098
20AD027	D	20	15	24.8	10.3	13.5	16.5	22	35	60	35	100	100	50	–	–	140M-F8E-C32	5098
20AD034	D	25	20	31.2	13	17	20.3	27	40	70	40	125	125	50	–	–	140M-F8E-C45	5098
20AD040	D	30	25	36.7	19.9	20	25.5	34	50	90	50	150	150	50	–	–	140M-F8E-C45	5098
20AD052	E	40	30	47.7	12.8	26	30	40	60	110	60	200	200	70	–	–	–	–
20AD065	E	50	40	59.6	24.8	32.5	39	52	80	125	80	250	250	100	–	–	–	–

See page 27 for notes.

Table 13 - 600 Volt AC Single-phase Input Drive Ratings and Input Protection Devices

Cat. No.	Frame (1)	Hp Rating		Input Ratings		Output Amps			Dual Element Time Delay Fuse		Non-time Delay Fuse		Circuit Breaker (4)	Motor Circuit Protector (6)	140M Motor Protector with Adjustable Current Range (7) (8)			
		ND	HD	Amps	kVA	Cont.	1 Min.	3 Sec.	Min (2)	Max (3)	Min (2)	Max (3)	Max (5)	Max (5)	Available Catalog Numbers (9)		Minimum Enclosure Volume (in. 3) (10)	
600 Volt AC Input																		
20AE0P9	A	0.5	0.33	1.3	0.7	0.5	0.6	0.7	3	3	3	3.5	15	3	140M-C2E-B16	–	–	3441
20AE1P7	A	1	0.75	1.9	1	0.9	1	1.3	3	6	3	6	15	3	140M-C2E-B25	140M-D8E-B25	–	3441
20AE2P7	A	2	1.5	3	1.6	1.4	1.8	2.4	4	6	4	10	15	7	140M-C2E-B40	140M-D8E-B40	–	3441
20AE3P9	B	3	2	4.4	2.3	2	2.2	3	6	8	6	15	15	7	–	140M-D8E-B63	–	3441
20AE6P1	B	5	3	7.5	3.9	3.1	3.4	4.6	10	12	10	20	20	15	–	140M-D8E-C10	140M-F8E-C10	3441
20AE9P0	C	7.5	5	7.7	4	4.5	5	6.8	10	20	10	35	35	15	–	140M-D8E-C10	140M-F8E-C10	3441
20AE011	C	10	7.5	9.8	5.1	5.5	6.8	9	15	20	15	40	40	15	–	140M-D8E-C16	140M-F8E-C16	3441
20AE017	D	15	10	15.3	8	8.5	9.4	12.8	20	35	20	60	60	30	–	–	140M-F8E-C20	5098
20AE022	D	20	15	20	10.4	11	12.8	17	25	45	25	80	80	30	–	–	140M-F8E-C25	5098
20AE027	D	25	20	24.8	12.9	13.5	16.5	22	35	60	35	100	100	50	–	–	140M-F8E-C25	5098
20AE032	D	30	25	29.4	15.3	16	20.3	27	40	70	40	125	125	50	–	–	140M-F8E-C32	5098
20AE041	E	40	30	37.6	19.6	20.5	24	32	50	90	50	150	150	100	–	–	–	–
20AE052	E	50	40	47.7	24.8	26	30.8	41	60	110	60	200	200	100	–	–	–	–

(1) For IP 66 (NEMA/UL Type 4X/12) enclosures, drives listed as Frame A increase to Frame B and drives listed as Frame C increase to Frame D.

(2) Minimum protection device size is the lowest rated device that supplies maximum protection without nuisance tripping.

(3) Maximum protection device size is the highest rated device that supplies drive protection. For US NEC, minimum size is 125% of motor FLA. Ratings shown are maximum.

(4) Circuit Breaker - inverse time breaker. For US NEC, minimum size is 125% of motor FLA. Ratings shown are maximum.

(5) Maximum allowable rating by US NEC. Exact size must be chosen for each installation.

(6) Motor Circuit Protector - instantaneous trip circuit breaker. For US NEC, minimum size is 125% of motor FLA. Ratings shown are maximum.

(7) Bulletin 140M with adjustable current range must have the current trip set to the minimum range that the device will not trip.

(8) Manual Self-Protected (Type E) Combination Motor Controller, UL listed for 208 Wye or Delta, 240 Wye or Delta, 480Y/277 or 600Y/347. Not UL listed for use on 480V or 600V Delta/Delta, corner ground, or high-resistance ground systems.

(9) The AIC ratings of the Bulletin 140M Motor Protector Circuit Breakers may vary. See [Bulletin 140M Motor Protection Circuit Breakers Application Ratings](#).

(10) When using a Manual Self-Protected (Type E) Combination Motor Controller, the drive must be installed in a ventilated or non-ventilated enclosure with the minimum volume specified in this column. Application specific thermal considerations may require a larger enclosure.

Maximum Motor Cable Lengths

In the following tables, an 'X' in the columns indicates that this drive rating can be used with an Allen-Bradley terminator (1204-TFA1/1204-TFB2) and/or reflected wave reduction device with common mode choke (1204-RWC-17) or without a choke (1204-RWR2).

- For the terminator, the maximum cable length is 182.9 m (600 ft) for 400/480/600V drives. The PWM frequency must be 2 kHz. The 1204-TFA1 can be used only on low Hp (5 Hp and below), while the 1204-TFB2 can be used from 2...800 Hp.
- 1204 reflected wave reduction device (all motor insulation classes):
 - (1) 1204-RWR2-09
 - 2kHz: 182.9 m (600 ft) at 400/480V, and 121.9 m (400 ft) at 600V
 - 4 kHz: 91.4 m (300 ft) at 400/480V, and 61.0 m (200 ft) at 600V
 - (2) 1204-RWC-17
 - 2 kHz: 365.8 m (1200 ft) at 400/480/600V
 - 4 kHz: 243.8 m (800 ft) at 400/480V, and 121.9 m (400 ft) at 600V

For both devices, power dissipation in the damping resistor limits maximum cable length.

The 1321-RWR is a complete reflected wave reduction solution available for many of the PowerFlex drives. If available, a 1321-RWR catalog number is indicated in the Reactor/RWR column. When not available, use the reactor and resistor information in [Table 14 on page 28](#) to build a solution.

Table 14 - Reactor and Resistor Information

For Further Information on ...	See Publication ...
1321-RWR	1321 Power Conditioning Products Technical Data, publication 1321-TD001
1204-RWR2	1204 Reflected Wave Reduction Device Instructions, publication 1204-5.1
1204-RWC	1204 Reflected Wave Reduction Device with Common Mode Choke Installation Instructions, publication 1204-IN001
1204-TFxx	1204 Terminator Instructions, publication 1204-IN002

Table 15 - PowerFlex 70 (standard/enhanced), 400V Shielded/Unshielded Cable – Meters (Feet)

Drive Frame	Rating		No Solution				Reactor Only				Reactor + Damping Resistor or 1321-RWR				Reactor/RWR	Resistor		Available Options				
	kW	kHz	1000V	1200V	1488V	1600V	1000V	1200V	1488V	1600V	1000V	1200V	1488V	1600V	Cat. No.	Ohms	Watts	TFA1	TFB2	RWR2	RWC	
A	0.37	2	7.6 (25)	53.3 (175)	53.3 (175)	53.3 (175)	91.4 (300)	121.9 (400)	121.9 (400)	121.9 (400)	121.9 (400)	121.9 (400)	121.9 (400)					X		X	X	
		4	7.6 (25)	53.3 (175)	53.3 (175)	53.3 (175)	18.3 (60)	91.4 (300)	121.9 (400)	121.9 (400)	121.9 (400)	121.9 (400)	121.9 (400)	121.9 (400)						X	X	
	0.75	2	7.6 (25)	83.8 (275)	83.8 (275)	83.8 (275)	91.4 (300)	152.4 (500)	152.4 (500)	152.4 (500)	152.4 (500)	152.4 (500)	152.4 (500)	152.4 (500)					X		X	X
		4	7.6 (25)	76.2 (250)	76.2 (250)	76.2 (250)	18.3 (60)	91.4 (300)	152.4 (500)	152.4 (500)	152.4 (500)	152.4 (500)	152.4 (500)	152.4 (500)							X	X
	1.5	2	7.6 (25)	83.8 (275)	83.8 (275)	83.8 (275)	91.4 (300)	182.9 (600)	182.9 (600)	182.9 (600)	182.9 (600)	182.9 (600)	182.9 (600)	182.9 (600)					X	X	X	X
		4	7.6 (25)	76.2 (250)	76.2 (250)	76.2 (250)	18.3 (60)	91.4 (300)	182.9 (600)	182.9 (600)	182.9 (600)	182.9 (600)	182.9 (600)	182.9 (600)							X	X
B	2.2	2	7.6 (25)	137.2 (450)	182.9 (600)	182.9 (600)	91.4 (300)	182.9 (600)	182.9 (600)	182.9 (600)	182.9 (600)	182.9 (600)	182.9 (600)	182.9 (600)					X	X	X	X
		4	7.6 (25)	91.4 (300)	152.4 (500)	182.9 (600)	18.3 (60)	91.4 (300)	182.9 (600)	182.9 (600)	182.9 (600)	182.9 (600)	182.9 (600)	182.9 (600)							X	X
	4	2	7.6 (25)	137.2 (450)	243.8 (800)	243.8 (800)	91.4 (300)	243.8 (800)	243.8 (800)	243.8 (800)	243.8 (800)	243.8 (800)	243.8 (800)	243.8 (800)	1321-RWR8-DP					X		X
		4	7.6 (25)	91.4 (300)	152.4 (500)	213.4 (700)	18.3 (60)	91.4 (300)	243.8 (800)	243.8 (800)	243.8 (800)	243.8 (800)	243.8 (800)	243.8 (800)	1321-RWR8-DP							X
C	5.5	2	7.6 (25)	137.2 (450)	304.8 (1000)	304.8 (1000)	91.4 (300)	304.8 (1000)	304.8 (1000)	304.8 (1000)	304.8 (1000)	304.8 (1000)	304.8 (1000)	304.8 (1000)	1321-RWR12-DP					X		X
		4	7.6 (25)	91.4 (300)	152.4 (500)	213.4 (700)	18.3 (60)	91.4 (300)	304.8 (1000)	304.8 (1000)	304.8 (1000)	182.9 (600)	304.8 (1000)	304.8 (1000)	1321-RWR12-DP							X
	7.5	2	7.6 (25)	137.2 (450)	365.8 (1200)	365.8 (1200)	91.4 (300)	365.8 (1200)	365.8 (1200)	365.8 (1200)	365.8 (1200)	365.8 (1200)	365.8 (1200)	365.8 (1200)	1321-RWR18-DP					X		X
		4	7.6 (25)	91.4 (300)	152.4 (500)	213.4 (700)	18.3 (60)	91.4 (300)	365.8 (1200)	365.8 (1200)	182.9 (600)	304.8 (1000)	365.8 (1200)	365.8 (1200)	1321-RWR18-DP							X
D	11	2	7.6 (25)	137.2 (450)	365.8 (1200)	365.8 (1200)	91.4 (300)	365.8 (1200)	365.8 (1200)	365.8 (1200)	365.8 (1200)	365.8 (1200)	365.8 (1200)	365.8 (1200)	1321-RWR25-DP					X		
		4	7.6 (25)	91.4 (300)	152.4 (500)	213.4 (700)	18.3 (60)	91.4 (300)	365.8 (1200)	365.8 (1200)	182.9 (600)	304.8 (1000)	365.8 (1200)	365.8 (1200)	1321-RWR25-DP							
	15	2	7.6 (25)	137.2 (450)	365.8 (1200)	365.8 (1200)	91.4 (300)	365.8 (1200)	365.8 (1200)	365.8 (1200)	365.8 (1200)	365.8 (1200)	365.8 (1200)	365.8 (1200)	1321-RWR35-DP					X		
		4	7.6 (25)	91.4 (300)	152.4 (500)	213.4 (700)	18.3 (60)	91.4 (300)	365.8 (1200)	365.8 (1200)	182.9 (600)	304.8 (1000)	365.8 (1200)	365.8 (1200)	1321-RWR35-DP							
D	18.5	2	7.6 (25)	137.2 (450)	365.8 (1200)	365.8 (1200)	91.4 (300)	365.8 (1200)	365.8 (1200)	365.8 (1200)	365.8 (1200)	365.8 (1200)	365.8 (1200)	365.8 (1200)	1321-RWR35-DP					X		
		4	7.6 (25)	91.4 (300)	152.4 (500)	213.4 (700)	18.3 (60)	91.4 (300)	365.8 (1200)	365.8 (1200)	182.9 (600)	304.8 (1000)	365.8 (1200)	365.8 (1200)	1321-RWR35-DP							
D	22	2	7.6 (25)	137.2 (450)	365.8 (1200)	365.8 (1200)	91.4 (300)	365.8 (1200)	365.8 (1200)	365.8 (1200)	365.8 (1200)	365.8 (1200)	365.8 (1200)	365.8 (1200)	1321-RWR45-DP					X		
		4	7.6 (25)	91.4 (300)	152.4 (500)	213.4 (700)	18.3 (60)	91.4 (300)	365.8 (1200)	365.8 (1200)	182.9 (600)	304.8 (1000)	365.8 (1200)	365.8 (1200)	1321-RWR45-DP							
E	30	2	7.6 (25)	137.2 (450)	304.8 (1000)	365.8 (1200)	91.4 (300)	365.8 (1200)	365.8 (1200)	365.8 (1200)	365.8 (1200)	365.8 (1200)	365.8 (1200)	365.8 (1200)	1321-RWR55-DP					X		
		4	7.6 (25)	91.4 (300)	152.4 (500)	213.4 (700)	18.3 (60)	91.4 (300)	365.8 (1200)	365.8 (1200)	182.9 (600)	304.8 (1000)	365.8 (1200)	365.8 (1200)	1321-RWR55-DP							
	37	2	12.2 (40)	137.2 (450)	304.8 (1000)	365.8 (1200)	91.4 (300)	365.8 (1200)	365.8 (1200)	365.8 (1200)	365.8 (1200)	365.8 (1200)	365.8 (1200)	365.8 (1200)	1321-RWR80-DP					X		
		4	12.2 (40)	91.4 (300)	152.4 (500)	213.4 (700)	18.3 (60)	91.4 (300)	365.8 (1200)	365.8 (1200)	182.9 (600)	304.8 (1000)	365.8 (1200)	365.8 (1200)	1321-RWR80-DP							

Table 16 - PowerFlex 70 (standard/enhanced), 480V Shielded/Unshielded Cable – Meters (Feet)

Drive Frame	Rating		No Solution				Reactor Only				Reactor + Damping Resistor or 1321-RWR				Reactor/RWR		Resistor		Available Options			
	Hp	kHz	1000V	1200V	1488V	1600V	1000V	1200V	1488V	1600V	1000V	1200V	1488V	1600V	Cat. No.	Ohms	Watts	TF1	TF2	RWR2	RWC	
A	0.5	2	7.6 (25)	12.2 (40)	53.3 (175)	53.3 (175)	7.6 (25)	91.4 (300)	121.9 (400)	121.9 (400)	121.9 (400)	121.9 (400)	121.9 (400)	121.9 (400)				X		X	X	
		4	7.6 (25)	12.2 (40)	53.3 (175)	53.3 (175)	7.6 (25)	12.2 (40)	121.9 (400)	121.9 (400)	121.9 (400)	121.9 (400)	121.9 (400)	121.9 (400)						X	X	
	1	2	7.6 (25)	12.2 (40)	83.8 (275)	83.8 (275)	7.6 (25)	91.4 (300)	152.4 (500)	152.4 (500)	152.4 (500)	152.4 (500)	152.4 (500)	152.4 (500)				X		X	X	
		4	7.6 (25)	12.2 (40)	76.2 (250)	76.2 (250)	7.6 (25)	12.2 (40)	121.9 (400)	152.4 (500)	152.4 (500)	152.4 (500)	152.4 (500)	152.4 (500)						X	X	
	2	2	7.6 (25)	12.2 (40)	83.8 (275)	83.8 (275)	7.6 (25)	91.4 (300)	182.9 (600)	182.9 (600)	182.9 (600)	182.9 (600)	182.9 (600)	182.9 (600)				X	X	X	X	
		4	7.6 (25)	12.2 (40)	76.2 (250)	76.2 (250)	7.6 (25)	12.2 (40)	121.9 (400)	182.9 (600)	182.9 (600)	182.9 (600)	182.9 (600)	182.9 (600)						X	X	
	B	3	2	7.6 (25)	12.2 (40)	129.5 (425)	129.5 (425)	7.6 (25)	91.4 (300)	182.9 (600)	182.9 (600)	182.9 (600)	182.9 (600)	182.9 (600)	182.9 (600)				X	X	X	X
			4	7.6 (25)	12.2 (40)	121.9 (400)	121.9 (400)	7.6 (25)	12.2 (40)	121.9 (400)	182.9 (600)	182.9 (600)	182.9 (600)	182.9 (600)	182.9 (600)						X	X
5		2	7.6 (25)	12.2 (40)	137.2 (450)	182.9 (600)	7.6 (25)	91.4 (300)	243.8 (800)	243.8 (800)	182.9 (600)	243.8 (800)	243.8 (800)	243.8 (800)	1321-RWR8-DP			X	X	X	X	
		4	7.6 (25)	12.2 (40)	121.9 (400)	182.9 (600)	7.6 (25)	12.2 (40)	121.9 (400)	243.8 (800)	182.9 (600)	243.8 (800)	243.8 (800)	243.8 (800)	1321-RWR8-DP					X	X	
C	7.5	2	7.6 (25)	12.2 (40)	137.2 (450)	182.9 (600)	7.6 (25)	91.4 (300)	304.8 (1000)	304.8 (1000)	182.9 (600)	304.8 (1000)	304.8 (1000)	304.8 (1000)	1321-RWR12-DP				X		X	
		4	7.6 (25)	12.2 (40)	121.9 (400)	182.9 (600)	7.6 (25)	12.2 (40)	121.9 (400)	304.8 (1000)	182.9 (600)	304.8 (1000)	304.8 (1000)	304.8 (1000)	1321-RWR12-DP						X	
	10	2	7.6 (25)	12.2 (40)	137.2 (450)	182.9 (600)	7.6 (25)	91.4 (300)	365.8 (1200)	365.8 (1200)	182.9 (600)	365.8 (1200)	365.8 (1200)	365.8 (1200)	1321-RWR18-DP				X		X	
		4	7.6 (25)	12.2 (40)	121.9 (400)	182.9 (600)	7.6 (25)	12.2 (40)	121.9 (400)	304.8 (1000)	182.9 (600)	304.8 (1000)	365.8 (1200)	365.8 (1200)	1321-RWR18-DP						X	
D	15	2	7.6 (25)	12.2 (40)	137.2 (450)	182.9 (600)	7.6 (25)	91.4 (300)	365.8 (1200)	365.8 (1200)	182.9 (600)	365.8 (1200)	365.8 (1200)	365.8 (1200)	1321-RWR25-DP				X			
		4	7.6 (25)	12.2 (40)	121.9 (400)	182.9 (600)	7.6 (25)	12.2 (40)	121.9 (400)	304.8 (1000)	182.9 (600)	304.8 (1000)	365.8 (1200)	365.8 (1200)	1321-RWR25-DP							
	20	2	7.6 (25)	12.2 (40)	137.2 (450)	182.9 (600)	7.6 (25)	91.4 (300)	365.8 (1200)	365.8 (1200)	182.9 (600)	365.8 (1200)	365.8 (1200)	365.8 (1200)	1321-RWR35-DP				X			
		4	7.6 (25)	12.2 (40)	121.9 (400)	182.9 (600)	7.6 (25)	12.2 (40)	121.9 (400)	304.8 (1000)	182.9 (600)	304.8 (1000)	365.8 (1200)	365.8 (1200)	1321-RWR35-DP							
	25	2	7.6 (25)	12.2 (40)	137.2 (450)	182.9 (600)	7.6 (25)	76.2 (250)	365.8 (1200)	365.8 (1200)	182.9 (600)	365.8 (1200)	365.8 (1200)	365.8 (1200)	1321-RWR35-DP				X			
		4	7.6 (25)	12.2 (40)	121.9 (400)	182.9 (600)	7.6 (25)	12.2 (40)	121.9 (400)	274.3 (900)	152.4 (500)	304.8 (1000)	365.8 (1200)	365.8 (1200)	1321-RWR35-DP							
	30	2	7.6 (25)	12.2 (40)	137.2 (450)	182.9 (600)	7.6 (25)	76.2 (250)	365.8 (1200)	365.8 (1200)	182.9 (600)	365.8 (1200)	365.8 (1200)	365.8 (1200)	1321-RWR45-DP				X			
		4	7.6 (25)	12.2 (40)	121.9 (400)	182.9 (600)	7.6 (25)	12.2 (40)	121.9 (400)	243.8 (800)	152.4 (500)	304.8 (1000)	365.8 (1200)	365.8 (1200)	1321-RWR45-DP							
E	40	2	7.6 (25)	12.2 (40)	137.2 (450)	182.9 (600)	7.6 (25)	76.2 (250)	365.8 (1200)	365.8 (1200)	152.4 (500)	365.8 (1200)	365.8 (1200)	365.8 (1200)	1321-RWR55-DP				X			
		4	7.6 (25)	12.2 (40)	106.7 (350)	152.4 (500)	7.6 (25)	12.2 (40)	106.7 (350)	228.6 (750)	121.9 (400)	243.8 (800)	365.8 (1200)	365.8 (1200)	1321-RWR55-DP							
	50	2	12.2 (40)	18.3 (60)	137.2 (450)	182.9 (600)	12.2 (40)	61.0 (200)	304.8 (1000)	365.8 (1200)	152.4 (500)	365.8 (1200)	365.8 (1200)	365.8 (1200)	1321-RWR80-DP				X			
		4	7.6 (25)	12.2 (40)	91.4 (300)	152.4 (500)	12.2 (40)	18.3 (60)	106.7 (350)	228.6 (750)	91.4 (300)	243.8 (800)	365.8 (1200)	365.8 (1200)	1321-RWR80-DP							

Table 17 - PowerFlex 70 (standard/enhanced), 600V Shielded/Unshielded Cable – Meters (Feet)

Drive Frame	Rating		No Solution		Reactor Only		1321-RWR		RWR	Available Options			
	Hp	kHz	1488V	1850V	1488V	1850V	1488V	1850V	Cat. No.	TFA1	TFB2	RWR2	RWC
A	1	2	42.7 (140)	121.9 (400)	121.9 (400)	121.9 (400)	121.9 (400)	121.9 (400)		X		X	X
		4	30.5 (100)	121.9 (400)	30.5 (100)	121.9 (400)	121.9 (400)	121.9 (400)				X	X
	2	2	42.7 (140)	152.4 (500)	152.4 (500)	152.4 (500)	152.4 (500)	152.4 (500)		X		X	X
		4	30.5 (100)	137.2 (450)	30.5 (100)	152.4 (500)	152.4 (500)	152.4 (500)				X	X
B	3	2	42.7 (140)	152.4 (500)	152.4 (500)	182.9 (600)	182.9 (600)	182.9 (600)		X		X	X
		4	30.5 (100)	137.2 (450)	30.5 (100)	152.4 (500)	182.9 (600)	182.9 (600)				X	X
	5	2	42.7 (140)	152.4 (500)	152.4 (500)	243.8 (800)	243.8 (800)	243.8 (800)	1321-RWR8-EP	X		X	X
		4	30.5 (100)	137.2 (450)	30.5 (100)	152.4 (500)	243.8 (800)	243.8 (800)	1321-RWR8-EP			X	X
C	7.5	2	42.7 (140)	152.4 (500)	152.4 (500)	304.8 (1000)	304.8 (1000)	304.8 (1000)	1321-RWR12-EP				X
		4	30.5 (100)	137.2 (450)	30.5 (100)	152.4 (500)	304.8 (1000)	304.8 (1000)	1321-RWR12-EP				X
	10	2	42.7 (140)	182.9 (600)	152.4 (500)	365.8 (1200)	365.8 (1200)	365.8 (1200)	1321-RWR12-EP				X
		4	30.5 (100)	137.2 (450)	30.5 (100)	152.4 (500)	304.8 (1000)	365.8 (1200)	1321-RWR12-EP				X
D	15	2	42.7 (140)	182.9 (600)	152.4 (500)	365.8 (1200)	365.8 (1200)	365.8 (1200)	1321-RWR18-EP				
		4	30.5 (100)	137.2 (450)	30.5 (100)	152.4 (500)	304.8 (1000)	365.8 (1200)	1321-RWR18-EP				
	20	2	42.7 (140)	182.9 (600)	152.4 (500)	365.8 (1200)	365.8 (1200)	365.8 (1200)	1321-RWR25-EP		X		
		4	30.5 (100)	137.2 (450)	30.5 (100)	152.4 (500)	304.8 (1000)	365.8 (1200)	1321-RWR25-EP				
	25	2	42.7 (140)	182.9 (600)	152.4 (500)	365.8 (1200)	365.8 (1200)	365.8 (1200)	1321-RWR35-EP		X		
		4	30.5 (100)	137.2 (450)	30.5 (100)	152.4 (500)	304.8 (1000)	365.8 (1200)	1321-RWR35-EP				
	30	2	42.7 (140)	182.9 (600)	152.4 (500)	365.8 (1200)	365.8 (1200)	365.8 (1200)	1321-RWR35-EP		X		
		4	30.5 (100)	137.2 (450)	36.6 (120)	152.4 (500)	304.8 (1000)	365.8 (1200)	1321-RWR35-EP				
E	40	2	42.7 (140)	182.9 (600)	152.4 (500)	365.8 (1200)	365.8 (1200)	365.8 (1200)	1321-RWR45-EP		X		
		4	30.5 (100)	137.2 (450)	36.6 (120)	152.4 (500)	304.8 (1000)	365.8 (1200)	1321-RWR45-EP				
	50	2	42.7 (140)	182.9 (600)	152.4 (500)	365.8 (1200)	365.8 (1200)	365.8 (1200)	1321-RWR55-EP		X		
		4	36.6 (120)	137.2 (450)	45.7 (150)	152.4 (500)	304.8 (1000)	365.8 (1200)	1321-RWR55-EP				

Mounting

This section includes information for mounting the drives.

Maximum Surrounding Air Temperature

Enclosure Rating	Temperature Range
Open Type, IP 20, NEMA/UL Type 1 and flange mount	0...50 °C (32...122 °F)
IP 66, NEMA/UL Type 4X/12	0...40 °C (32...104 °F)
IP 54, NEMA/UL Type 12	0...40 °C (32...104 °F)

IMPORTANT Some drives are equipped with an adhesive label on the top of the chassis. Removing the adhesive label from the drive changes the enclosure rating from NEMA/UL Type 1 Enclosed to Type Open.

Minimum Mounting Clearances

Specified vertical clearance requirements are intended to be from the drive to the closest object that can restrict airflow through the drive heat sink and chassis. The drive must be mounted in a vertical orientation as shown, and must make full contact with the mounting surface. Do not use standoffs or spacers. In addition, inlet air temperature must not exceed the product specification.

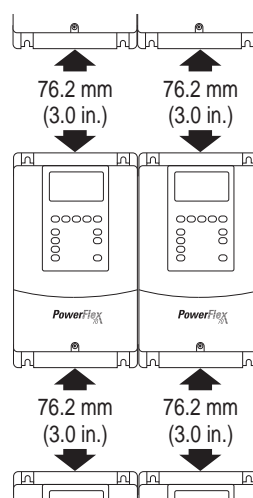

Clearances apply to all PowerFlex 70 Drives:
 • Panel Mount
 • Flange Mount
 • NEMA Type 4X/12

PowerFlex 70 Frames Output Power

Output Power		Frame Size							
kW ND (HD)	Hp ND (HD)	208...240V AC Input			400...480V AC Input			600V AC Input	
		Not Filtered	Filtered	IP66 (4X/12)	Not Filtered	Filtered	IP66 (4X/12)	Not Filtered	Filtered
0.37 (0.25)	0.5 (0.33)	A	B	B	A	B	B	A	—
0.75 (0.55)	1 (0.75)	A	B	B	A	B	B	A	—
1.5 (1.1)	2 (1.5)	B	B	B	A	B	B	A	—
2.2 (1.5)	3 (2)	B	B	B	B	B	B	B	—
4 (3)	5 (3)	—	C	D	B	B	B	B	—
5.5 (4)	7.5 (5)	—	D	D	—	C	D	C	—
7.5 (5.5)	10 (7.5)	—	D	D	—	C	D	C	—
11 (7.5)	15 (10)	—	D	D	—	D	D	D	—
15 (11)	20 (15)	—	E	E	—	D	D	D	—
18.5 (15)	25 (20)	—	E	E	—	D	D	—	—
22 (18.5)	30 (25)	—	—	—	—	D	D	—	—
30 (22)	40 (30)	—	—	—	—	E	E	—	—
37 (30)	50 (40)	—	—	—	—	E	E	—	—

Approximate Dimensions and Weights

This section provides the approximate dimensions for the drives.

Figure 1 - Frames A...E

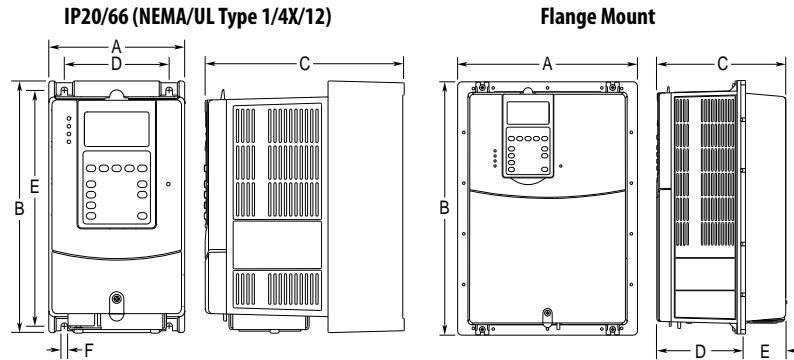

Table 18 - Frame Dimensions, mm (in.)

Frame Size	Dimension						Weight ⁽¹⁾ kg (lb)
	A	B	C	D	E	F	
IP20, NEMA/UL Type 1							
A	122.4 (4.82)	225.7 (8.89)	179.8 (7.08)	94.2 (3.71)	211.6 (8.33)	5.8 (0.23)	2.71 (6.0)
B	171.7 (6.76)	234.6 (9.24)	179.8 (7.08)	122.7 (4.83)	220.2 (8.67)	5.8 (0.23)	3.60 (7.9)
C	185.0 (7.28)	300.0 (11.81)	179.8 (7.08)	137.6 (5.42)	285.6 (11.25)	5.8 (0.23)	6.89 (15.2)
D	219.9 (8.66)	350.0 (13.78)	179.8 (7.08)	169.0 (6.65)	335.6 (13.21)	5.8 (0.23)	9.25 (20.4)
E	280.3 (11.04)	555.8 (21.88)	207.1 (8.15)	200.0 (7.87)	491.0 (19.33)	6.9 (0.27)	18.60 (41.0)
IP66, NEMA/UL Type 4X/12							
B	171.7 (6.76)	239.8 (9.44)	203.3 (8.00)	122.7 (4.83)	220.2 (8.67)	5.8 (0.23)	3.61 (8.0)
D	219.9 (8.66)	350.0 (13.78)	210.7 (8.29)	169.0 (6.65)	335.6 (13.21)	5.8 (0.23)	9.13 (20.1)
E	280.3 (11.04)	555.8 (21.88)	219.8 (8.65)	200.0 (7.87)	491.0 (19.33)	6.9 (0.27)	18.60 (41.0)
Flange Mount							
A	156.0 (6.14)	225.8 (8.89)	178.6 (7.03)	123.0 (4.84)	55.6 (2.19)	—	2.71 (6.0)
B	205.2 (8.08)	234.6 (9.24)	178.6 (7.03)	123.0 (4.84)	55.6 (2.19)	—	3.60 (7.9)
C	219.0 (8.62)	300.0 (11.81)	178.6 (7.03)	123.0 (4.84)	55.6 (2.19)	—	6.89 (15.2)
D	248.4 (9.78)	350.0 (13.78)	178.6 (7.03)	123.0 (4.84)	55.6 (2.19)	—	9.25 (20.4)
E	280.3 (11.04)	555.8 (21.88)	207.1 (8.15)	117.2 (4.61)	89.9 (3.54)	—	18.60 (41.0)

(1) Weights include HIM and standard I/O.

Figure 2 - IP20, NEMA/UL Type 1 Bottom View Dimensions, mm (in.)

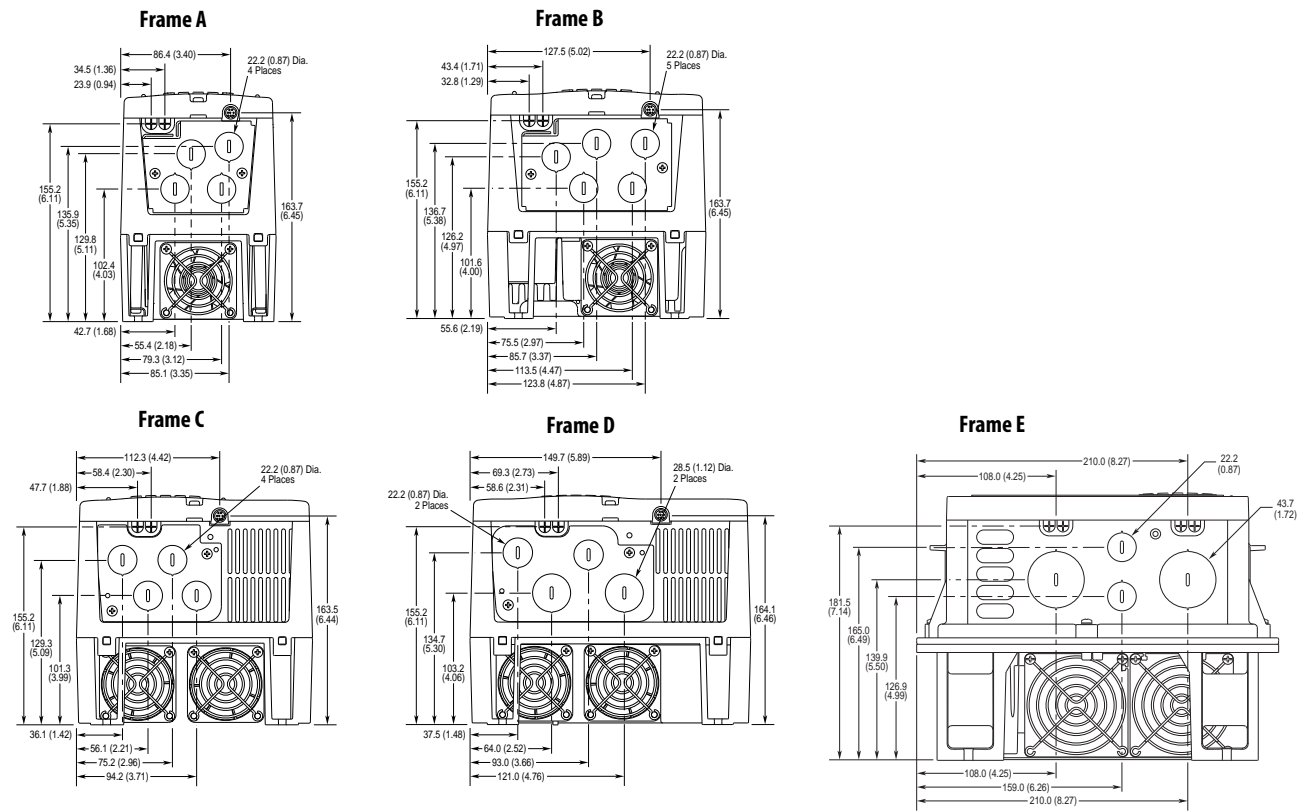

Figure 3 - IP 66 (NEMA/UL Type 4X/12) Bottom View Dimensions, mm (in.)

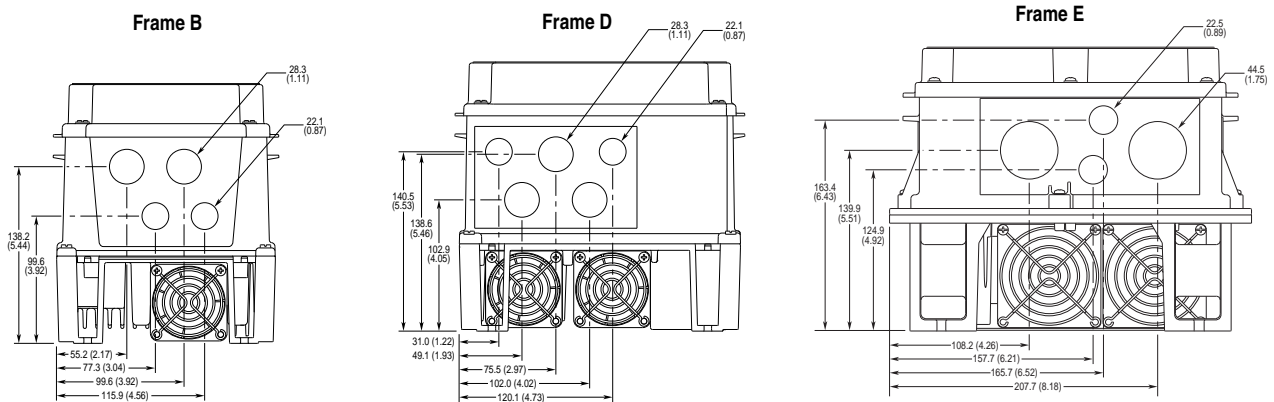

Figure 4 - Flange Mount Bottom View Dimensions, mm (in.)

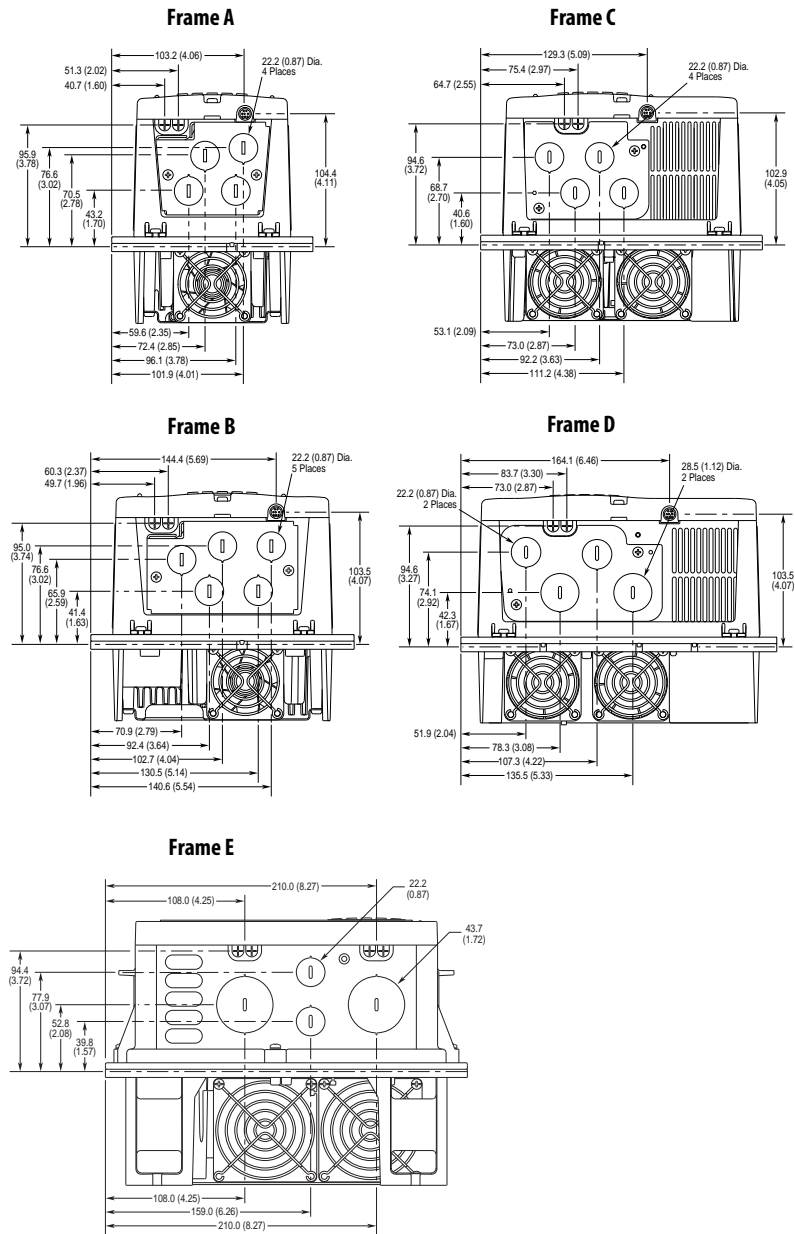

Figure 5 - Cutout Dimensions, mm (in.)

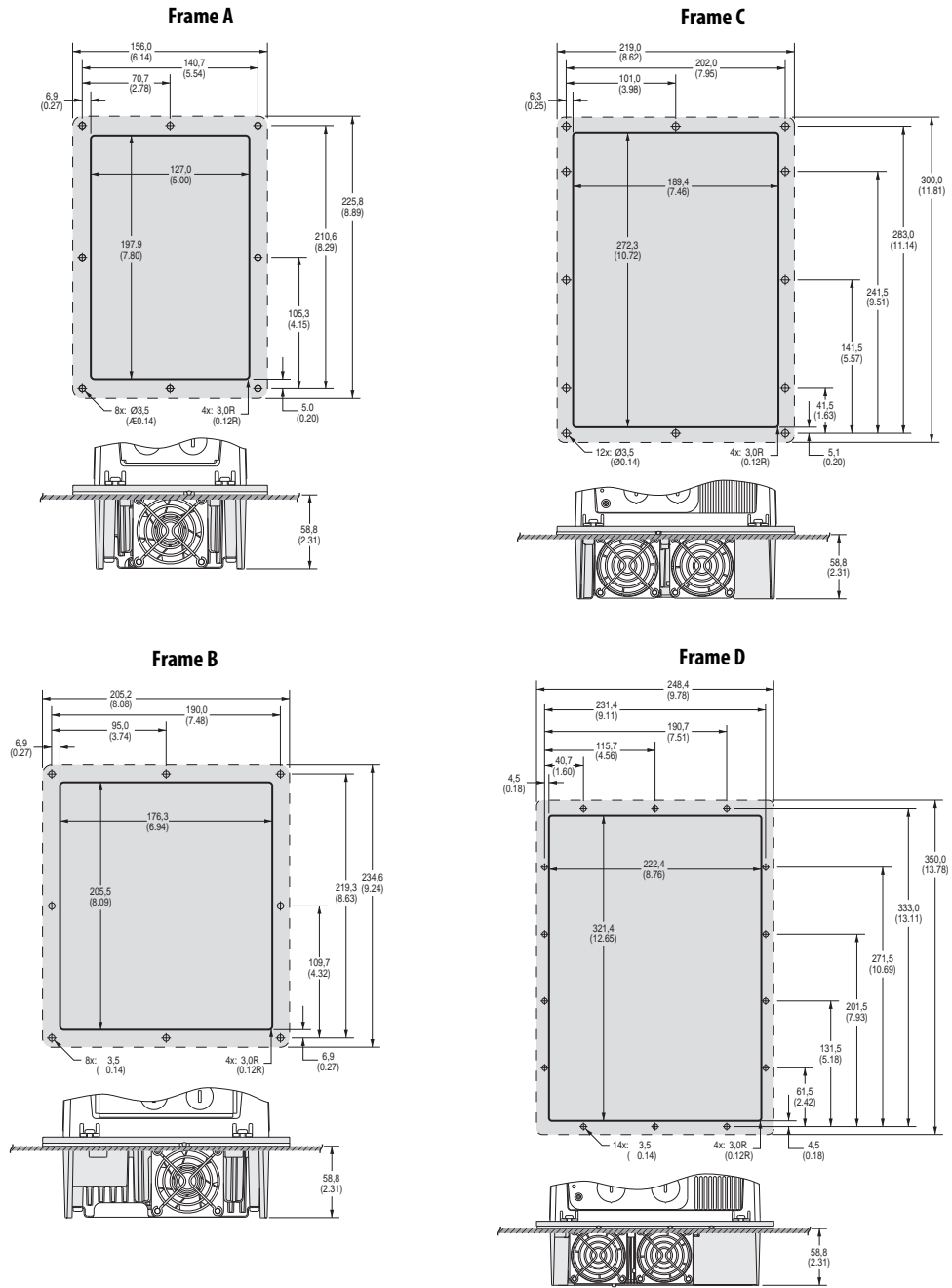
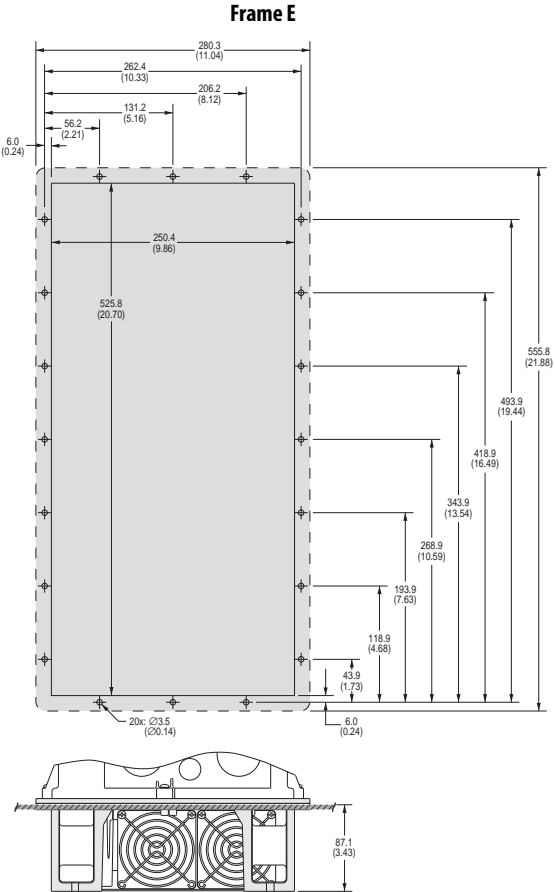

Figure 6 - Cutout Dimensions, mm (in.) (continued)



PowerFlex 70 Configured Drives

The PowerFlex 70 packaged drives program lets you create drive packages based on your specific needs. This program enhances stand-alone drive functionality through additional control, power, and packaging options that are ideal for original equipment manufacturers (OEM) and customers with special installation needs.

Catalog-configured Drives Program

The catalog configured drives program lets you create drive packages based on your specific needs. A complete drive package can be specified by assembling a single catalog number string that includes a base drive and all required options. Packaging is available for 480V requirements in NEMA Type 1 (IP20), NEMA 4/12 (IP65) indoor, and NEMA 3/4 (IP65) outdoor ratings. Focused on higher volume, repeat business, the standard designs provide consistent manufacturing and minimizes customer resources by reducing engineering, manufacturing, and installation time.

TIP This program supports the enhanced control version of the PowerFlex 70 drive.

NEMA Type 1

NEMA Type 4/12 Indoor

NEMA Type 3/4 Outdoor

- Enhanced control
- Flange mount drive
- Welded construction
- 480V rating

All Enclosure Types

- Drive input protection options
- Input/Output contactors
- Bypass options
- Input/Output line reactor options
- 115V control power options
- Control interface and feedback options
- Human interface modules
- Motor interface options
- Operator devices
- Drawing and test options



Figure 7 - Approximate Dimensions

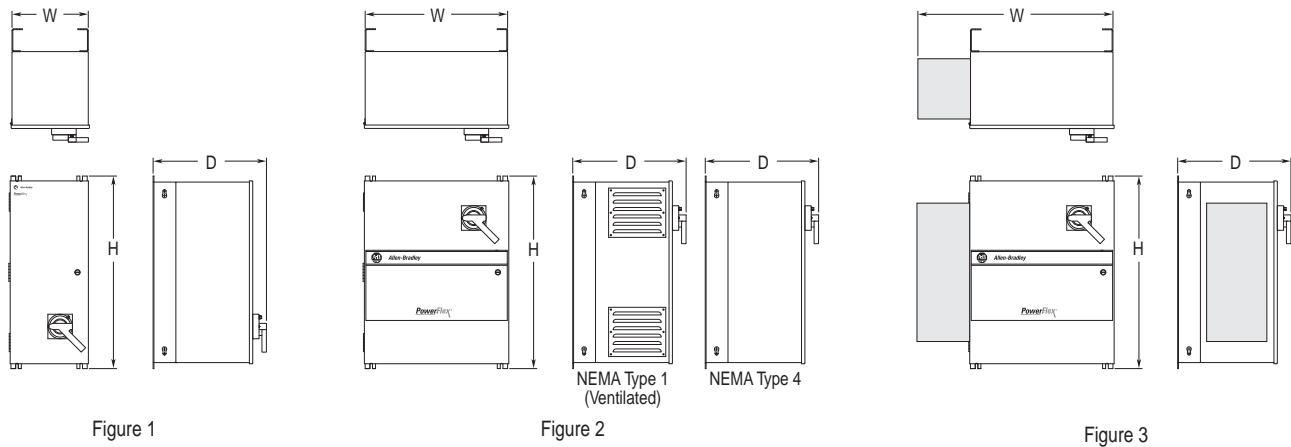

Table 19 - Maximum Enclosure Dimensions

Ratings ND Hp	HD Hp	Drive Frame Size	Power Flex 70 Flange Drive Cat. No.	Enclosure Style for Flange Mounted Drives													
				NEMA Type 1, Option Code A				NEMA Type 4 Indoor, Option Code D NEMA Type 12 Indoor, Option Code G				NEMA Type 3/4, Option Code E					
				B0, C1, C5, S1, S9...S13, S16, P1...P3 or P6, Drive Mounted Options & All HIMs		All Options		B0, C1, C5, S1, S9...S13, S16, P1...P3 or P6, Drive Mounted Options & All NEMA 4 HIMs		All Options Less Line Reactor		All Options		B0, C1, C5, S1, S9...S13, S16, P1...P3 or P6, Drive Mounted Options		All Options Less Line Reactor	
Figure	Style	Figure	Style	Figure	Style	Figure	Style	Figure	Style	Figure	Style	Figure	Style	Figure	Style		
480V AC, Three-phase Drives																	
0.5	0.33	A	D1P1	1	1	2	3	1	1	2	3	2	3	1	1	2	3
1.0	0.75	A	D2P1	1	1	2	3	1	1	2	3	2	3	1	1	2	3
2.0	1.5	A	D3P4	1	1	2	3	1	1	2	3	2	3	1	1	2	3
3.0	2.0	B	D5P0	1	1	2	3	1	1	2	3	2	4	1	1	2	3
5.0	3.0	B	D8P0	1	1	2	3	1	1	2	3	2	4	1	1	2	3
7.5	5.0	C	D011	1	1	2	3	1	1	2	3	2	4	1	1	2	3
10	7.5	C	D014	1	1	2	3	1	1	2	3	2	4	1	1	2	3
15	10	D	D022	1	1	2	4	1	1	2	4	2	5	16	1	2	4
20	15	D	D027	1	1	2	4	1	1	2	4	2	5	1	1	2	4
25	20	D	D034	1	1	2	4	1	1	2	4	2	5	1	1	2	4
30	25	D	D040	1	1	2	4	1	1	2	4	2	5	1	1	2	4
40	30	E	D052	1	2	2	6	1	2	2	6	2	7	1	2	2	6
50	40	E	D065	1	2	2	6	1	2	2	6	2	7	1	2	2	6

● Figure 2, Style 5, when one line reactor is selected. Figure 3, Style 8, when two line reactors are selected.

Table 20 - Enclosure Dimensions

Figure	Style	Enclosure Rating	Option Code (Position d)	Dimensions	
				H x W x D (mm)	H x W x D (in.)
1	1	NEMA 1	A	812.8 x 330.2 x 484.1	32 x 13 x 19.06
1	2	NEMA 1	A	1,270.0 x 406.4 x 484.1	50 x 16 x 19.06
2	3	NEMA 1	A	812.8 x 609.6 x 484.1	32 x 24 x 19.06
2	4	NEMA 1	A	965.2 x 609.6 x 484.1	38 x 24 x 19.06
2	6	NEMA 1	A	1,270.0 x 762.0 x 484.1	50 x 30 x 19.06
1	1	NEMA 4/12 Indoor, NEMA 4 Outdoor	D, G, E	812.8 x 330.2 x 484.1	32 x 13 x 19.06
1	2	NEMA 4/12 Indoor, NEMA 4 Outdoor	D, G, E	1,270.0 x 406.4 x 484.1	50 x 16 x 19.06
2	3	NEMA 4/12 Indoor, NEMA 4 Outdoor	D, G, E	812.8 x 609.6 x 484.1	32 x 24 x 19.06
2	4	NEMA 4/12 Indoor, NEMA 4 Outdoor	D, G, E	965.2 x 609.6 x 484.1	38 x 24 x 19.06
2	5	NEMA 4/12 Indoor, NEMA 4 Outdoor	D, G, E	1,270.0 x 609.6 x 484.1	50 x 24 x 19.06
2	6	NEMA 4/12 Indoor, NEMA 4 Outdoor	D, G, E	1,270.0 x 762.0 x 484.1	50 x 30 x 19.06
2	7	NEMA 4/12 Indoor, NEMA 4 Outdoor	D, G, E	1,270.0 x 914.4 x 484.1	50 x 36 x 19.06
3	8	NEMA 4/12 Indoor, NEMA 4 Outdoor	D, G, E	812.8 x 831.9 x 484.1	50 x 32.75 x 19.06
3	9	NEMA 4/12 Indoor, NEMA 4 Outdoor	D, G, E	1,270.0 x 984.3 x 484.1	50 x 38.75 x 19.06

● Depth includes 6.35 mm (2.5 in) for operator handle, if ordered.

Standard Drive Certifications and Specifications

[Table 21](#) through [Table 24](#) provide certification information and technical specifications.

Table 21 - Certifications

Certifications ⁽¹⁾	Description	Frames	
		A...E 240...480V	A...E 600V
ABS	American Bureau of Shipping MA Certificate 08-HS303172A/1-PDA for auxiliary services on AB Classed vessels and offshore platforms	X	X
C-Tick	Certified by Rockwell Automation to be in conformity with the requirements of the applicable Australian legislation and standards referenced below: IEC 61800-3	X	
c-UL-us	Listed to UL508C and CAN/CSA C22.2 No. 14-05 Configured drives can be listed to UL508A	X	X
EN	Certified by Rockwell Automation to be in conformity with the essential requirements of the applicable European Directives and the standards referenced below have been applied: 2006/95/EC (Low Voltage Directive) EN 50178 Electronic Equipment for Use in Power Installations 2004/108/EC (EMC Directive) EN 61800-3 Adjustable speed electrical power drive systems - Part 3: EMC requirements and specific test methods	X	X
EPRI/SEMIF 47	EPRI Quality Star Certificates SEMIF47.115, SEMIF47.116, and SEMIF47.127 for SEMI F47 compliance, 480V units tested	X	
IEC 61800-2	Adjustable speed electrical power drive systems - Part 2: General requirements - Rating specifications for low voltage adjustable frequency AC power drive systems	X	X
Korean KC Registration	KCC-REM-RAA-20A Refer to the certificate of registration for specific drive catalog numbers that have this certification. ⁽¹⁾	X	X
Lloyd's Register	Lloyd's Register Type Approval Certificate 08 / 60014 (marine certification)	X	
NEMA ICS 7.1	Safety Standards for Construction and Guide for Selection, Installation, and Operation of Adjustable Speed Drive Systems	X	X
NFPA 70	US National Electric Code	X	X
NSF	Type 4X enclosure NSF Listed to meet Criteria C2 for splash and non-food zones	X	X
Trentec	Tested by Trentec to be compliant with AC156 Acceptance Criteria for Seismic Qualification Testing of Nonstructural Components and 2003 International Building Code for worst-case seismic level for USA excluding site class F	X	X
TÜV	TÜV Rheinland Certificate T72041027 01 tested to EN 50178	X	X
	TÜV Rheinland Certificate of a Competent Body AV 72061059 0001 for compliance with EMC Directive (89/336/EEC)	X	
	TÜV Rheinland Certificate 968/EZ 166.01/06 Safe Off Option satisfies requirements for Category 3 safety function according to EN 954-1	X	

(1) See the product certifications website, <http://www.rockwellautomation.com/products/certification/>, for declarations of conformity, certificates, and other certification details.

Table 22 - Specifications

Category	Specification						
Protection	Drive	200... 208V	240V	380/400	480V	600V	690V
	AC input overvoltage trip	247V AC	285V AC	475V AC	570V AC	690V AC	
	AC input undervoltage trip	120V AC	138V AC	233V AC	280V AC	345V AC	
	Bus overvoltage trip	405V DC	405V DC	810V DC	810V DC	1013V DC	
	Bus undervoltage output shutoff	300V DC	300V DC	407V DC	407V DC	508V DC	
	Bus undervoltage fault level	160V DC	160V DC	300V DC	300V DC	375V DC	
	Nominal bus voltage	281V DC	324V DC	540V DC	648V DC	810V DC	
	All Drives						
	Heat sink thermistor	Monitored by microprocessor overtemp trip					
	Drive overcurrent trip						
	Software current limit	20...160% of rated current					
	Hardware current limit	200% of rated current (typical)					
	Instantaneous current limit	220...300% of rated current (dependent on drive rating)					
	Line transients	Up to 6000 volts peak per IEEE C62.41-1991					
Control logic noise immunity	Showering arc transients up to 1500V peak						
Power ride-thru	15 milliseconds at full load						
Logic control ride-thru	0.5 seconds minimum, 2 seconds typical						
Ground fault trip	Phase-to-ground on drive output						
Short circuit trip	Phase-to-phase on drive output						
Environment	Altitude	1000 m (3300 ft) max without derating					
	Maximum surrounding air temperature without derating						
	IP20, NEMA/UL Type 1 flange mount	0...50 °C (32...122 °F) 0...50 °C (32...122 °F)					
	IP66, NEMA/UL Type 4X/12 (indoor)	0...40 °C (32...104 °F)					
	Cooling fan operation						
	Frames A and C	Fan operates when power is applied.					
	Frames B, D, and E	Fan operates when power is applied and in Run condition.					
	Storage temperature (all const.)	-40...70 °C (-40...158 °F)					
	Atmosphere	Important: Drive must not be installed in an area where the ambient atmosphere contains volatile or corrosive gas, vapors, or dust. If the drive is not going to be installed for a period of time, store the drive where it is not exposed to a corrosive atmosphere.					
	Relative humidity	5...95% non-condensing					
	Shock	15 g peak for 11 ms duration (±1.0 ms)					
	Vibration	0.152 mm (0.006 in.) displacement, 1 g peak					
Surrounding environment							
Pollution degree:							
Pollution degree 1 and 2	All enclosures are acceptable for pollution degree 1 and 2.						
Pollution degree 3 and 4	An enclosure that meets or exceeds IP54, NEMA/UL Type 12, is required for pollution degree 3 and 4.						
See Table 23 on page 41 for descriptions of pollution degree rating.							

Table 23 - Pollution Degree Ratings According to EN 61800-5-1

Pollution Degree	Description
1	No pollution or only dry non-conductive pollution occurs. The pollution has no influence.
2	Normally only non-conductive pollution occurs. Occasionally a temporary conductivity, caused by condensation, is expected when the drive is out of operation.
3	Conductive pollution or dry non-conductive pollution occurs, that becomes conductive due to condensation, and is expected.
4	The pollution generates persistent conductivity caused, for example, by conductive dust, rain, or snow.

Table 24 - Specifications (continued)

Category	Specification	
Electrical	Voltage tolerance	-10% of minimum, +10% of maximum. See page 121 for Full Power and Operating Range.
	Input frequency tolerance	47...63 Hz.
	Input phases	Three-phase input provides full rating for all drives. Single-phase operation provides 50% of rated current.
	Displacement power factor (all drives)	0.98 across speed range.
	Efficiency	97.5% at rated amps, nominal line volts.
	Maximum short circuit rating	200,000 amps symmetrical.
	Max short circuit current rating (by using the recommended fuse or circuit breaker type)	Maximum short circuit current rating to match specified fuse/circuit breaker capability.
	Drive to motor power ratio Minimum Maximum	Recommended not less than 1:2 ratio Recommended not greater than 2:1 ratio
Control	Method	Sine coded PWM with programmable carrier frequency. Ratings apply to all drives.
	Carrier frequency	2, 3, 4, 5, 6, 7, 8, 9, and 10 kHz Standard . 2, 4, 8, and 12 kHz EC . Drive rating based on 4 kHz.
	Output voltage range	0 to rated motor voltage
	Output frequency range	0...400 Hz Standard . 0...500 Hz EC .
	Frequency accuracy Digital input Analog input	Within $\pm 0.01\%$ of set output frequency. Within $\pm 0.4\%$ of maximum output frequency.
	Frequency control - speed regulation	with slip compensation (V/Hz mode) 0.5% of base speed across 40:1 speed range 40:1 operating range 10 rad/sec bandwidth
		with slip compensation (Sensorless Vector mode) 0.5% of base speed across 80:1 speed range 80:1 operating range 20 rad/sec bandwidth
		with feedback (Sensorless Vector mode) EC 0.001% of base speed across 40:1 speed range 0.1% of base speed across 80:1 speed range 80:1 operating range 20 rad/sec bandwidth
	Speed control - speed regulation	without feedback (Vector Control mode) EC 0.1% of base speed across 120:1 speed range 120:1 operating range 30 rad/sec bandwidth
		with feedback (Vector Control mode) EC 0.001% of base speed across 120:1 speed range 1000:1 operating range 125 rad/sec bandwidth
	Torque regulation	without feedback +/-10% EC
		with feedback +/-5% EC
	Selectable motor control	Sensorless Vector with full tuning. Standard V/Hz with full custom capability and vector control.
	Stop modes	Multiple programmable stop modes including - Ramp, Coast, DC-Brake, Fast Brake, Ramp-to-Hold and S-curve.
	Accel/Decel	Two independently programmable accel and decel times. Each time can be programmed from 0...3600 seconds in 0.1 second increments
	Intermittent overload	110% Overload capability for up to 1 minute 150% Overload capability for up to 3 seconds
Current limit capability	Proactive current limit programmable from 20...160% of rated output current. Independently programmable proportional and integral gain.	
Motor overload protection	Class 10 motor overload protection according to NEC article 430 and motor over-temperature protection according to NEC article 430.126 (A)(2). UL 508C File E59272.	

Table 24 - Specifications (continued)

Category	Specification	
Encoder	Type	Incremental, dual channel
	Supply	5V/12V Configurable $\pm 5\%$
	Quadrature	$90^\circ \pm 27^\circ$
	Duty cycle	50% +10%
	Requirements	<p>Encoders must be line driver type, quadrature (dual-channel) or pulse (single-channel), single-ended or differential and capable of supplying a minimum of 10 mA per channel.</p> <p>The encoder interface board accepts 5V or 12V DC square-wave with a minimum high state voltage of 3.5V DC (5V mode) and 7.0V DC (12V mode).</p> <p>Maximum low state voltage is 1V DC (for both 5V and 12V modes).</p> <p>Maximum input frequency is 250 kHz.</p>

Table 25 - Watts Loss (rated load, speed, and PWM)⁽¹⁾

Voltage	ND Hp	External Watts	Internal Watts	Total Watts Loss
208V	0.5	12.2	19.2	31.4
	1.0	30.7	20.5	51.2
	2.0	44.6	22.6	67.2
	3.0	67.3	25.4	92.7
	5.0	141.3	33.2	174.5
	7.5	205.7	34.2	239.9
	10	270.4	48.1	318.5
	15	385.6	40.3	425.9
	20	494.6	44.9	539.5
	25	650.7	51.6	702.3
240V	0.5	12.2	19.2	31.4
	1.0	30.7	20.5	51.2
	2.0	44.6	22.6	67.2
	3.0	67.3	25.4	92.7
	5.0	141.3	33.2	174.5
	7.5	205.7	34.2	239.9
	10	270.4	48.1	318.5
	15	385.6	40.3	425.9
	20	494.6	44.9	539.5
	25	650.7	51.6	702.3
400V	0.37	11.5	17.9	29.4
	0.75	27.8	19.5	47.3
	1.5	43.6	21.6	65.2
	2.2	64.6	24.0	88.6
	4.0	99.5	28.2	127.7
	5.5	140.0	27.8	167.8
	7.5	193.3	32.0	225.3
	11	305.4	34.2	339.6
	15	432.9	42.9	475.8
	18.5	363.8	40.5	404.3
	22	396.8	41.5	438.3
	30	500.8	50.0	550.8
	37	632.0	57.7	689.7
480V	0.5	11.5	17.9	29.4
	1.0	27.8	19.5	47.3
	2.0	43.6	21.6	65.2
	3.0	64.6	24.0	88.6
	5.0	99.5	28.2	127.7
	7.5	140.0	27.8	167.8
	10	193.3	32.0	225.3
	15	305.4	34.2	339.6
	20	432.9	42.9	475.8
	25	363.8	40.5	404.3
	30	396.8	41.5	438.3
	40	500.8	50.0	550.8
	50	632.0	57.7	689.7
600V	0.5	11.5	17.9	29.4
	1.0	27.8	19.5	47.3
	2.0	43.6	21.6	65.2
	3.0	64.6	24.0	88.6
	5.0	99.5	28.2	127.7
	7.5	140.0	27.8	167.8
	10	193.3	32.0	225.3
	15	305.4	34.2	339.6
	20	432.9	42.9	475.8
	25	281.4	42.4	323.8
	30	311.9	43.4	355.3
	40	389.9	51.8	441.7
	50	501.4	59.9	561.3

⁽¹⁾ Worst case condition including Vector Control board, HIM and Communication Module

Voltage Tolerance

This section provides information to help you determine the voltage tolerance for your drive installation.

Drive Rating	Nominal Line Voltage	Nominal Motor Voltage	Drive Full Power Range	Drive Operating Range
200...240	200	200 †	200...264	180...264
	208	208	208...264	
	240	230	230...264	
380...400	380	380 †	380...528	342...528
	400	400	400...528	
	480	460	460...528	
500...600	600	575 †	575...660	432...660

Drive full power range = Nominal motor voltage to drive rated voltage + 10%.

Rated current is available across the entire drive full power range

Drive operating range = † Lowest nominal motor voltage - 10% to drive rated voltage + 10%.

Drive output is linearly derated when actual line voltage is less than the nominal motor voltage.

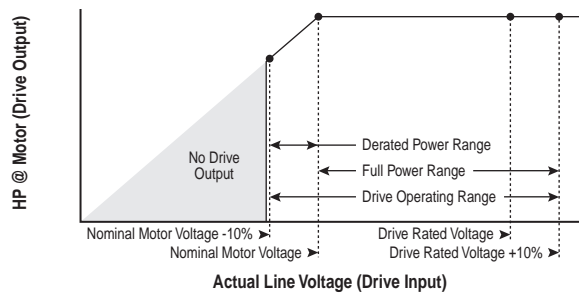

Example:

Calculate the maximum power of a 5 Hp, 460V motor connected to a 480V rated drive supplied with 342V actual line voltage input.

- Actual Line Voltage / Nominal Motor Voltage = 74.3%
- $74.3\% \times 5 \text{ Hp} = 3.7 \text{ Hp}$
- $74.3\% \times 60 \text{ Hz} = 44.6 \text{ Hz}$

At 342V actual line voltage, the maximum power the 5 Hp, 460V motor can produce is 3.7 Hp at 44.6 Hz.

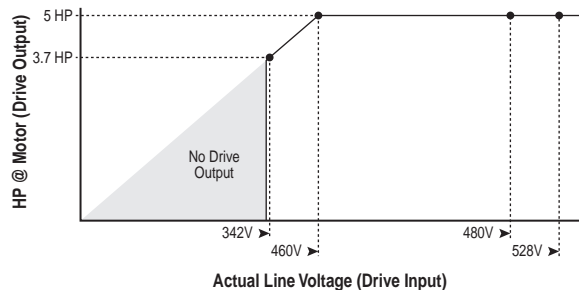

Derating Guidelines

Follow these guidelines for derating your drive installation.

Altitude and Efficiency

Frame	Type	Derate
All	Altitude	
	Efficiency (typical)	

Ambient Temperature/Load

Table 26 - 240V AC

PowerFlex 70 Power Rating		Derating
ND Hp	HD Hp	
240 Volt		--- 2 kHz - - - 4 kHz - · - · 6 kHz - - - 8 kHz ——— 10 kHz
0.5...3.0	0.33...2.0	None
5.0	3.0	
7.5	5.0	
10	7.5	
15	10	
20	15	
25	20	

Table 27 - 400V AC

PowerFlex 70 Power Rating		Derating
ND kW	HD kW	
400 Volt		
0.37...5.5	0.25...4.0	None
7.5	5.5	
11	7.5	
15	11	
18.5	15	
22	18.5	
30	22	

Table 27 - 400V AC (continued)

PowerFlex 70 Power Rating		Derating
ND kW	HD kW	
400 Volt		
37	30	

Table 28 - 480V AC

PowerFlex 70 Power Rating		Derating
ND Hp	HD Hp	
480 Volt		
0.5...7.5	0.33...5.0	None
10	7.5	
15	10	
20	15	
25	20	
30	25	

Table 28 - 480V AC (continued)

PowerFlex 70 Power Rating		Derating
ND Hp	HD Hp	
--- 2 kHz -.-.- 4 kHz — 6 kHz - - - 8 kHz — 10 kHz		
480 Volt		
40	30	
50	40	

Table 29 - 600V AC

PowerFlex 70 Power Rating		Derating
ND Hp	HD Hp	
--- 2 kHz -.-.- 4 kHz — 6 kHz - - - 8 kHz — 10 kHz		
600 Volt		
0.5...5.0	0.33...3.0	None
7.5	5.0	
10	7.5	
15	10	
20	15	

Table 29 - 600V AC (continued)

PowerFlex 70 Power Rating		Derating
ND Hp	HD Hp	
600 Volt		
25	20	
30	25	
40	30	
50	40	

Notes:

Important User Information

Read this document and the documents listed in the additional resources section about installation, configuration, and operation of this equipment before you install, configure, operate, or maintain this product. Users are required to familiarize themselves with installation and wiring instructions in addition to requirements of all applicable codes, laws, and standards.

Activities including installation, adjustments, putting into service, use, assembly, disassembly, and maintenance are required to be carried out by suitably trained personnel in accordance with applicable code of practice.

If this equipment is used in a manner not specified by the manufacturer, the protection provided by the equipment may be impaired.

In no event will Rockwell Automation, Inc. be responsible or liable for indirect or consequential damages resulting from the use or application of this equipment.

The examples and diagrams in this manual are included solely for illustrative purposes. Because of the many variables and requirements associated with any particular installation, Rockwell Automation, Inc. cannot assume responsibility or liability for actual use based on the examples and diagrams.

No patent liability is assumed by Rockwell Automation, Inc. with respect to use of information, circuits, equipment, or software described in this manual.

Reproduction of the contents of this manual, in whole or in part, without written permission of Rockwell Automation, Inc., is prohibited.

Documentation Feedback

Your comments will help us serve your documentation needs better. If you have any suggestions on how to improve this document, complete this form, publication [RA-DU002](#), available at <http://www.rockwellautomation.com/literature/>.

Allen-Bradley, Rockwell Software, Rockwell Automation, PowerFlex, FORCE, DriveExplorer, Drive Tools, DriveGuard, PanelView, RSLogix, and Zero-Stacking are trademarks of Rockwell Automation, Inc. Trademarks not belonging to Rockwell Automation are property of their respective companies.

Rockwell Otomasyon Ticaret A.Ş., Kar Plaza İş Merkezi E Blok Kat:6 34752 İçerenköy, İstanbul, Tel: +90 (216) 5698400

www.rockwellautomation.com

Power, Control and Information Solutions Headquarters

Americas: Rockwell Automation, 1201 South Second Street, Milwaukee, WI 53204-2496 USA, Tel: (1) 414.382.2000, Fax: (1) 414.382.4444
Europe/Middle East/Africa: Rockwell Automation NV, Pegasus Park, De Kleetlaan 12a, 1831 Diegem, Belgium, Tel: (32) 2 663 0600, Fax: (32) 2 663 0640
Asia Pacific: Rockwell Automation, Level 14, Core F, Cyberport 3, 100 Cyberport Road, Hong Kong, Tel: (852) 2887 4788, Fax: (852) 2508 1846

Publication 20A-TD0011-EN-P - August 2013

Supersedes Publication 20A-TD0011H-EN-P - November 2007

Copyright © 2013 Rockwell Automation, Inc. All rights reserved. Printed in the U.S.A.