



## Ethernet PLC-5 Programmable Controllers

Catalog Numbers 1785-L20E, 1785-L40E, 1785-L80E, Series F

### Contents

<b>For This Topic</b>	<b>See Page</b>
About This Publication	1
Related User Manual	5
About the Controllers	6
Install the System Hardware	13
Troubleshoot the Controller	20
Controller Specifications	24
Rockwell Automation Support	Back cover

### About This Publication

This document describes how to install and troubleshoot your Ethernet PLC-5 programmable controller. For more information, see the documents listed on the following page or contact your local Rockwell Automation representative.

These installation instructions:

- provide the basic information you need to get your system up and running.
- provide specific bit and switch settings for modules.
- include high-level procedures with cross-references to other manuals for more detail.

---

**IMPORTANT**

In this document, we assume you are using a Series F Ethernet PLC-5 programmable controller.

---

## Important User Information

Solid state equipment has operational characteristics differing from those of electromechanical equipment. Safety Guidelines for the Application, Installation and Maintenance of Solid State Controls (Publication SGI-1.1 available from your local Rockwell Automation sales office or online at <http://www.ab.com/manuals/gi>) describes some important differences between solid state equipment and hard-wired electromechanical devices. Because of this difference, and also because of the wide variety of uses for solid state equipment, all persons responsible for applying this equipment must satisfy themselves that each intended application of this equipment is acceptable.

In no event will Rockwell Automation, Inc. be responsible or liable for indirect or consequential damages resulting from the use or application of this equipment.

The examples and diagrams in this manual are included solely for illustrative purposes. Because of the many variables and requirements associated with any particular installation, Rockwell Automation, Inc. cannot assume responsibility or liability for actual use based on the examples and diagrams.

No patent liability is assumed by Rockwell Automation, Inc. with respect to use of information, circuits, equipment, or software described in this manual.

Reproduction of the contents of this manual, in whole or in part, without written permission of Rockwell Automation, Inc. is prohibited.

Throughout this manual we use notes to make you aware of safety considerations.

---

### WARNING



Identifies information about practices or circumstances that can cause an explosion in a hazardous environment, which may lead to personal injury or death, property damage, or economic loss.

---

### IMPORTANT

Identifies information that is critical for successful application and understanding of the product.

---

### ATTENTION



Identifies information about practices or circumstances that can lead to personal injury or death, property damage, or economic loss. Attentions help you:

- identify a hazard
  - avoid a hazard
  - recognize the consequence
- 

### SHOCK HAZARD



Labels may be located on or inside the equipment to alert people that dangerous voltage may be present.

---

### BURN HAZARD



Labels may be located on or inside the equipment to alert people that surfaces may be dangerous temperatures.

---

---

## Environment and Enclosure

**ATTENTION**

- This equipment is intended for use in a Pollution Degree 2 industrial environment, in overvoltage Category II applications (as defined in IEC publication 60664-1), at altitudes up to 2000 meters without derating.
- This equipment is considered Group 1, Class A industrial equipment according to IEC/CISPR Publication 11. Without appropriate precautions, there may be potential difficulties ensuring electromagnetic compatibility in other environments due to conducted as well as radiated disturbance.
- This equipment is supplied as “open type” equipment. It must be mounted within an enclosure that is suitably designed for those specific environmental conditions that will be present and appropriately designed to prevent personal injury resulting from accessibility to live parts. The interior of the enclosure must be accessible only by the use of a tool. Subsequent sections of this publication may contain additional information regarding specific enclosure type ratings that are required to comply with certain product safety certifications.
- Besides this publication, see:
  - Industrial Automation Wiring and Grounding Guidelines, Allen-Bradley publication 1770-4.1, for additional installation requirements.
  - NEMA Standards publication 250 and IEC publication 60529, as applicable, for explanations of the degrees of protection provided by different types of enclosure.

---

## Prevent Electrostatic Discharge

**ATTENTION**

This equipment is sensitive to electrostatic discharge that can cause internal damage and affect normal operation. Follow these guidelines when you handle this equipment.

- Touch a grounded object to discharge potential static.
  - Wear an approved grounding wrist strap.
  - Do not touch connectors or pins on component boards.
  - Do not touch circuit components inside the equipment.
  - Use a static-safe workstation, if available.
  - Store the equipment in appropriate static-safe packaging when not in use.
-

## North American Hazardous Location Approval

### The following information applies when operating this equipment in hazardous locations:

Products marked "CL I, DIV 2, GP A, B, C, D" are suitable for use in Class I Division 2 Groups A, B, C, D, Hazardous Locations and nonhazardous locations only. Each product is supplied with markings on the rating nameplate indicating the hazardous location temperature code. When combining products within a system, the most adverse temperature code (lowest "T" number) may be used to help determine the overall temperature code of the system. Combinations of equipment in your system are subject to investigation by the local Authority Having Jurisdiction at the time of installation.

### Informations sur l'utilisation de cet équipement en environnements dangereux :

Les produits marqués "CL I, DIV 2, GP A, B, C, D" ne conviennent qu'à une utilisation en environnements de Classe I Division 2 Groupes A, B, C, D dangereux et non dangereux. Chaque produit est livré avec des marquages sur sa plaque d'identification qui indiquent le code de température pour les environnements dangereux. Lorsque plusieurs produits sont combinés dans un système, le code de température le plus défavorable (code de température le plus faible) peut être utilisé pour déterminer le code de température global du système. Les combinaisons d'équipements dans le système sont sujettes à inspection par les autorités locales qualifiées au moment de l'installation.

#### EXPLOSION HAZARD

##### WARNING



- Do not disconnect equipment unless power has been removed or the area is known to be nonhazardous.
- Do not disconnect connections to this equipment unless power has been removed or the area is known to be nonhazardous. Secure any external connections that mate to this equipment by using screws, sliding latches, threaded connectors, or other means provided with this product.
- Substitution of components may impair suitability for Class I, Division 2.
- If this product contains batteries, they must only be changed in an area known to be nonhazardous.

##### AVERTISSEMENT



#### RISQUE D'EXPLOSION

- Couper le courant ou s'assurer que l'environnement est classé non dangereux avant de débrancher l'équipement.
- Couper le courant ou s'assurer que l'environnement est classé non dangereux avant de débrancher les connecteurs. Fixer tous les connecteurs externes reliés à cet équipement à l'aide de vis, loquets coulissants, connecteurs filetés ou autres moyens fournis avec ce produit.
- La substitution de composants peut rendre cet équipement inadapté à une utilisation en environnement de Classe I, Division 2.
- S'assurer que l'environnement est classé non dangereux avant de changer les piles.

## Related User Manual

The related user manual contains detailed information about configuring, programming, and using an Ethernet PLC-5 controller. To obtain a copy of the Enhanced and Ethernet PLC-5 Programmable Controllers User Manual, publication 1785-UM012, you can:

- view or download an electronic version from the Internet at [www.rockwellautomation.com/literature](http://www.rockwellautomation.com/literature).
- contact your local distributor or Rockwell Automation representative to place an order.

## Additional Related Documentation

The following documents contain additional information related to the products described in this document.

For More Information About	See This Publication	Number
Ethernet PLC-5 programmable controllers	Enhanced and Ethernet PLC-5 Programmable Controllers User Manual	1785-UM012
Universal 1771 I/O chassis	Universal I/O Chassis Installation Instructions	1771-2.210
Power supply	Power Supply Modules (1771-P4S, -P6S, -P4S1, -P6S1) Installation Instructions	1771-2.135
DH+ network, extended-local I/O	Enhanced and Ethernet PLC-5 Programmable Controllers User Manual	1785-UM012
	Data Highway/Data Highway Plus/Data Highway II/Data Highway-485 Cable Installation Instructions	1770-6.2.2
Communication cards	1784-KTx Communication Interface Card User Manual	1784-6.5.22
Cables	Enhanced and Ethernet PLC-5 Programmable Controllers User Manual	1785-UM012
Batteries	Allen-Bradley Guidelines for Lithium Battery Handling and Disposal	AG-5.4
Grounding and wiring Allen-Bradley programmable controllers	Allen-Bradley Programmable Controller Wiring and Grounding Guidelines	1770-4.1
Terms and definitions	Allen-Bradley Industrial Automation Glossary	AG-7.1

## About the Controllers

The following illustrations indicate the controller's front panel components.

### PLC-5/20E, -5/40E and -5/80E, Controller Front Panel

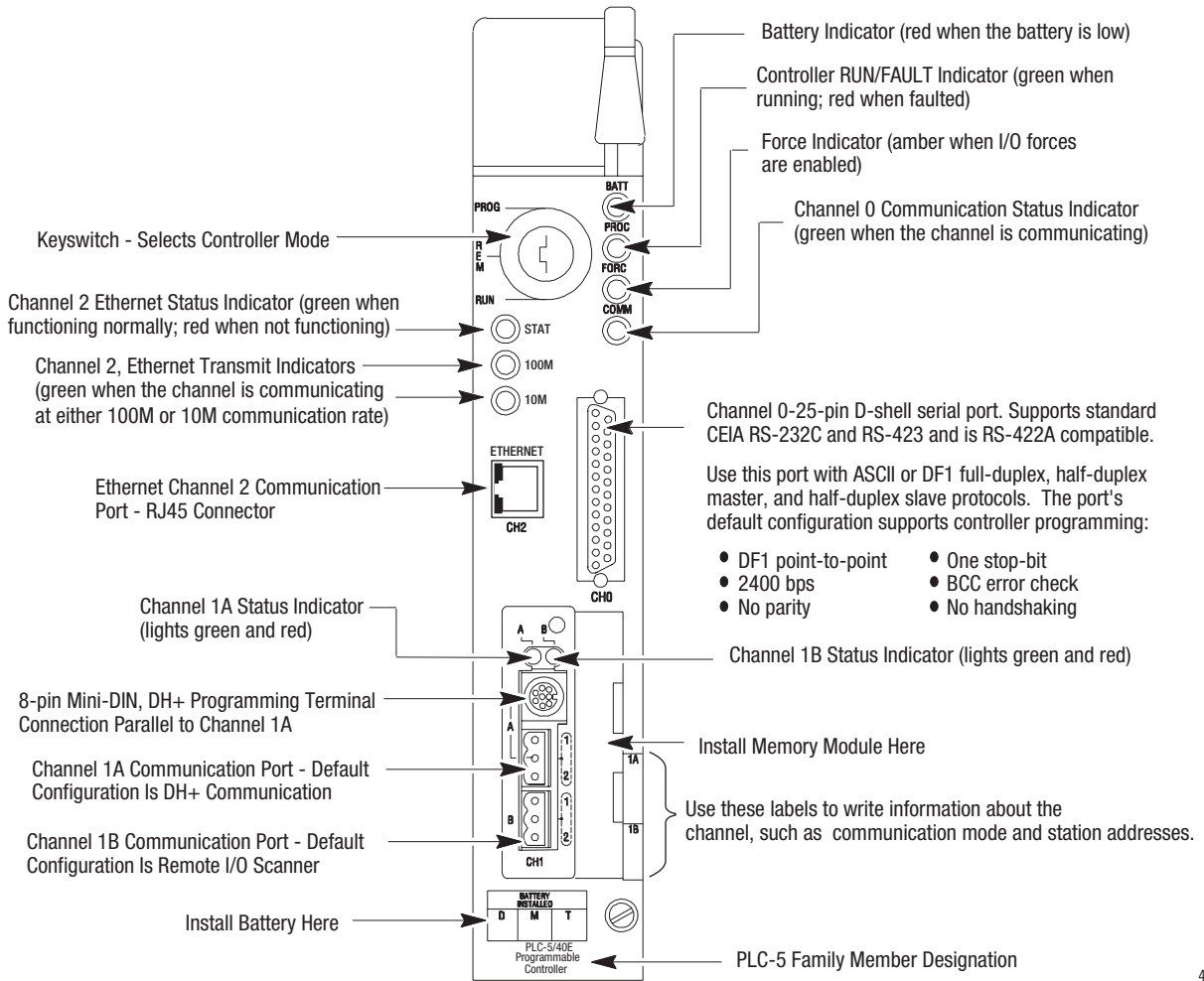

43909

## Additional System Components

Along with your controller, you need the following components to complete a basic system.

Product	Cat. No.
Lithium battery	1770-XYC
I/O chassis	1771-A1B, -A2B, -A3B, -A3B1, -A4B
Power supply	1771-P4S, -P6S, -P4S1, -P6S1
Personal computer	

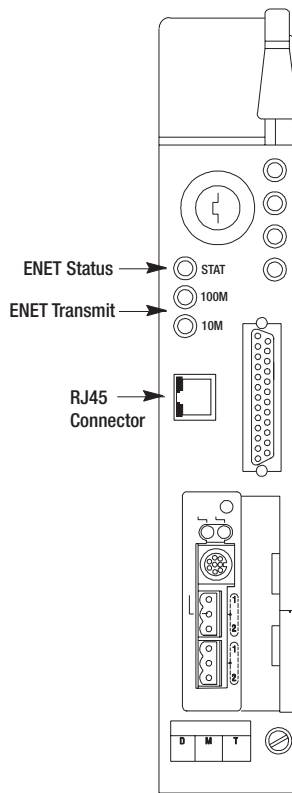

## New Features

The controllers contain an RJ-45 connector for the Channel 2 communication port.

The controllers provide additional Channel 2 port configuration and status:

- BOOTP, DHCP, or Static entry of IP address
- Auto Negotiate speed selection
- Full/Half Duplex port setting
- 10/100 speed selection
- Email client functionality
- Enable/Disable HTTP Web Server
- Enable/Disable SNMP functionality

To see or activate the new configuration and status features:

1. Open or create a project in RSLogix 5 software, version 7.1 or later.
2. Click on the Channel Configuration menu.

You see the Edit Channel Properties menu.

3. Click on the Channel 2 tab.

### *BOOTP, DHCP, or Static Entry of IP Address*

As shown in the following screen capture, you can select between a static or dynamic network configuration.

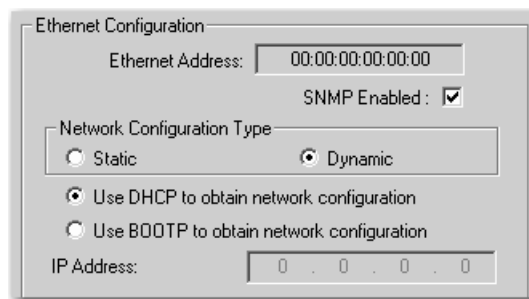

- The default is Dynamic Network Configuration Type and Use BOOTP to obtain network configuration.
- If you choose a dynamic network configuration, you can change the default BOOTP to DHCP.
- If you choose a static network configuration type, you must enter the IP address.

Similarly, if you have a dynamic network configuration, DHCP or BOOTP assigns the controller’s hostname. With a static configuration, you assign the hostname.

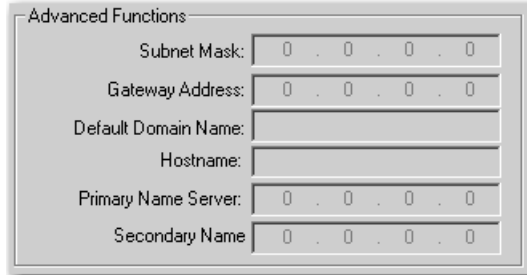

When you create a hostname, consider these naming conventions.

- The hostname can be a text string up to 24 characters.
- The hostname can contain alpha (A to Z) numeric (0 to 9) and may contain a period and minus sign.
- The first character must be an alpha character.
- The last character must not be a minus sign.
- You cannot use blank spaces or space characters.
- The hostname is not case-sensitive.

### *Auto Negotiate Speed Selection*

In the Edit Channel 2 properties box, you can either leave the Auto Negotiate box unchecked, which forces the port setting to a particular speed and duplex port setting, or you may check the Auto Negotiate box, which lets the controller negotiate a speed and duplex port setting.

If you check Auto Negotiate, the port setting lets you select the range of speed and duplex settings that the controller negotiates. The default port setting with Auto Negotiate checked is 10/100 Mbps Full Duplex/Half Duplex, which lets the controller negotiate any of its four available settings. The following table lists the order of negotiation for each setting.

<b>Setting</b>	<b>100 Mbps Full Duplex</b>	<b>100 Mbps Half Duplex</b>	<b>10 Mbps Full Duplex</b>	<b>10 Mbps Half Duplex</b>
10/100 Mbps Full Duplex/Half Duplex	1st	2nd	3rd	4th
100 Mbps Full Duplex or 100 Mbps Half Duplex	1st	2nd		3rd
100 Mbps Full Duplex or 10 Mbps Full Duplex	1st		2nd	3rd
100 Mbps Half Duplex or 10 Mbps Full Duplex		1st	2nd	3rd
100 Mbps Full Duplex	1st			2nd
100 Mbps Half Duplex		1st		2nd
10 Mbps Full Duplex			1st	2nd
10 Mbps Half Duplex Only				1st



The unchecked Auto Negotiate box and corresponding port settings are shown below.

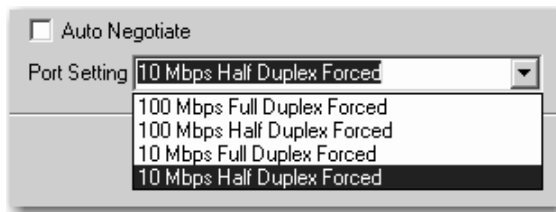

The checked Auto Negotiate box and corresponding port settings are shown below.

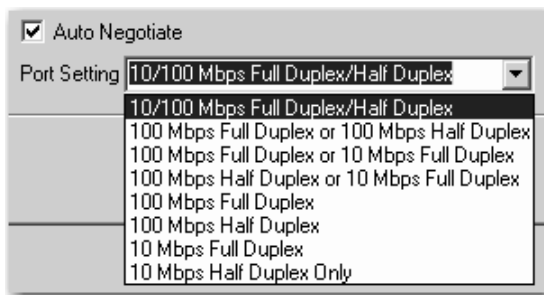

### *Email Client Functionality*

The controller is an email client that sends an email triggered by a message instruction via a mail relay server. The controller uses standard SMTP protocol to forward the email to the relay server. The controller does not receive email.

You must enter the SMTP Server's IP address into the text box as shown in the following dialog.

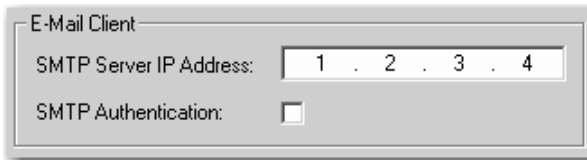

The controller supports login authentication. If you want the controller to authenticate to the SMTP server, check the SMTP authentication box. If you select authentication, you must also use a username and password for each email.

To create an email:

1. Create a message instruction similar to the one below.

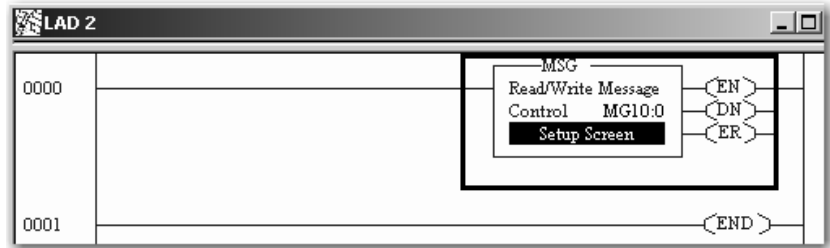

The destination (to), the reply (from), and the body (text) are stored as strings in elements of separate ASCII string files.

If you want to send an email to a specific recipient when a controller application generates an alarm or reaches a certain condition, program the controller to send the message instruction to the destination of the email.

2. Verify the rung.
3. Click on Setup Screen.

A dialog appears like the one below.

The three Data fields display the string values of the ST file element addresses.

- To send email, enter the appropriate information into the Data fields and Username and Password, if Authentication is enabled.

Examine the Error Code (denoted in Hex) and Error Description areas within the General tab to see if the message was successfully delivered.

Error Code (hex)	Description
0x000	Delivery successful to the mail relay server.
0x002	Resource unavailable. The email object was unable to obtain memory resources to initiate the SMTP session.
0x101	SMTP mail server IP address not configured.
0x102	To (destination) address not configured or invalid.
0x103	From (reply) address not configured or invalid.
0x104	Unable to connect to SMTP mail server.
0x105	Communication error with SMTP server.
0x106	Authentication required.
0x017	Authentication failed.

### Channel 2 Status

To check the status of channel 2:

- In your RSLogix 5 software project, click on Channel Status.

You see the Channel Status menu.

- Click on the Channel 2 tab.

- Click on the Port tab.

You see the status for each port configuration.

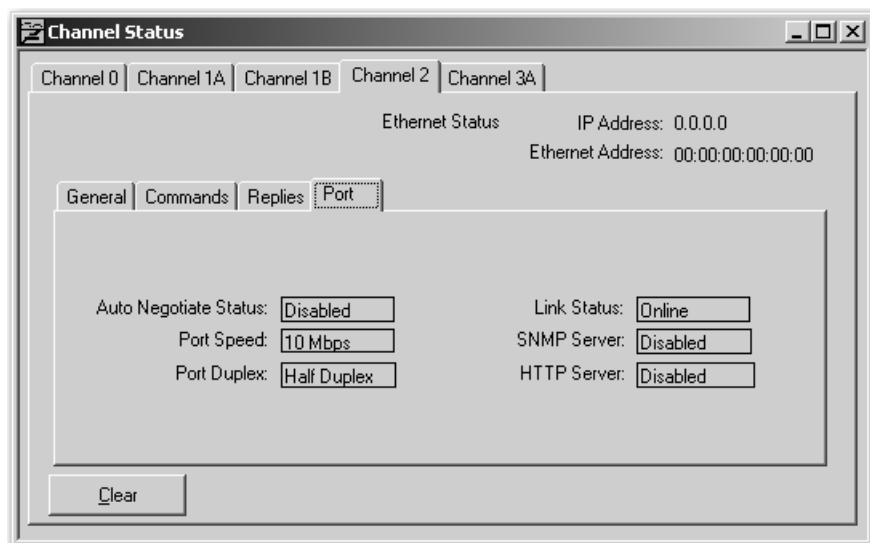

### Enable/Disable HTTP Web Server

You can disable the HTTP web server functionality from within the Channel 2 Configuration by unchecking the HTTP Server Enable check box shown below.

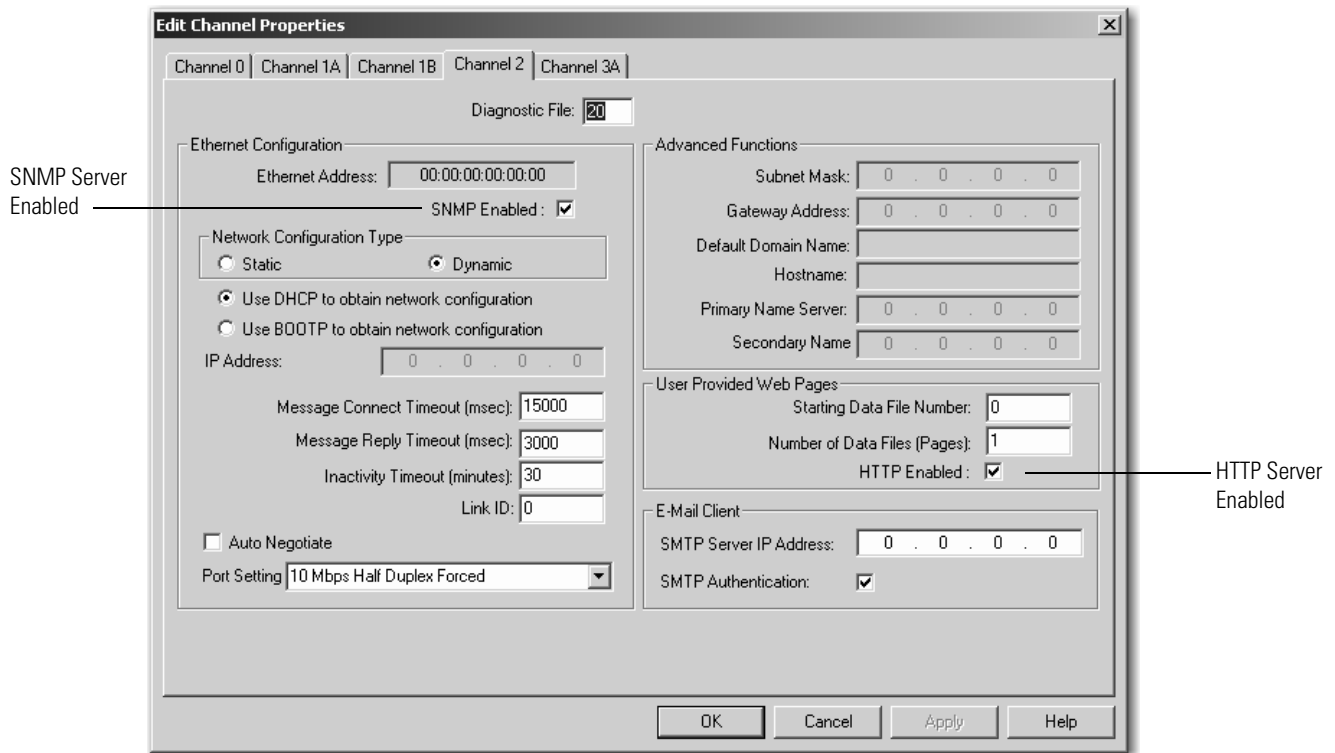

The default (checked box) lets you connect to the controller using a web browser. Although this parameter can be downloaded to the controller as part of a program download or changed and applied while online with the controller, you must cycle power to the controller for the change to take affect.

### Enable/Disable Simple Network Management Protocol (SNMP)

You can disable the controller's SNMP functionality from within the Channel 2 Configuration by unchecking the SNMP Server Enable check box as shown above.

The default (checked box) lets you connect to the controller using an SNMP client. Although this parameter can be downloaded to the controller as part of a program download or changed and applied while online with the controller, you must cycle power to the controller for the change to take affect.

## Install the System Hardware

This illustration shows a basic Ethernet PLC-5 programmable controller system.

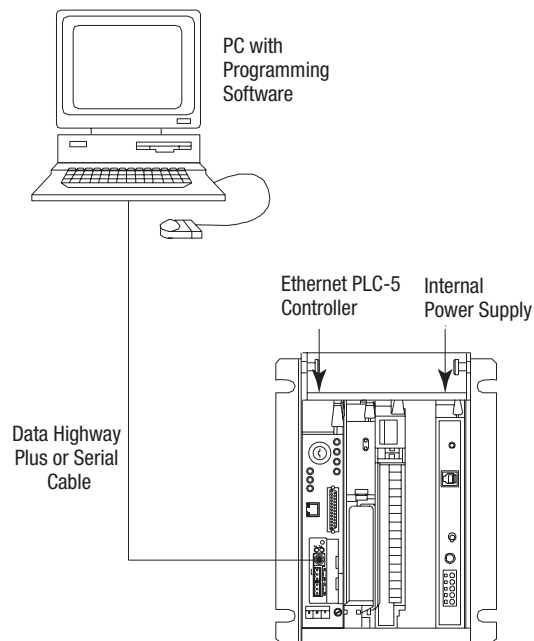

For more information, see the Enhanced and Ethernet PLC-5 Programmable Controllers User Manual, publication 1785-UM012.

### WARNING



If you connect or disconnect any communications cable with power applied to this module or any device on the network, an electrical arc can occur. This could cause an explosion in hazardous location installations. Be sure that power is removed or the area is nonhazardous before proceeding.

### WARNING



The local programming terminal port (circular mini-DIN style programming terminal connection) is intended for temporary use only and must not be connected or disconnected unless the area is assured to be nonhazardous.

## **Prepare to Install the Controller**

Installing the controller is one part of setting up the hardware in your system.

To properly install the controller, you must follow these procedures in the order described in this section.

1. Install an I/O Chassis.
2. Configure the I/O Chassis.
3. Install the Power Supply.
4. Install the PLC-5 Programmable Controller.
5. Apply Power to the System.
6. Connect the Personal Computer to the PLC-5 Programmable Controller.

### ***Install an I/O Chassis***

Install an I/O chassis according to the Universal I/O Chassis Installation Instructions, publication 1771-IN075.

### Configure the I/O Chassis

Configure the I/O chassis by following this procedure.

1. Set the backplane switches.

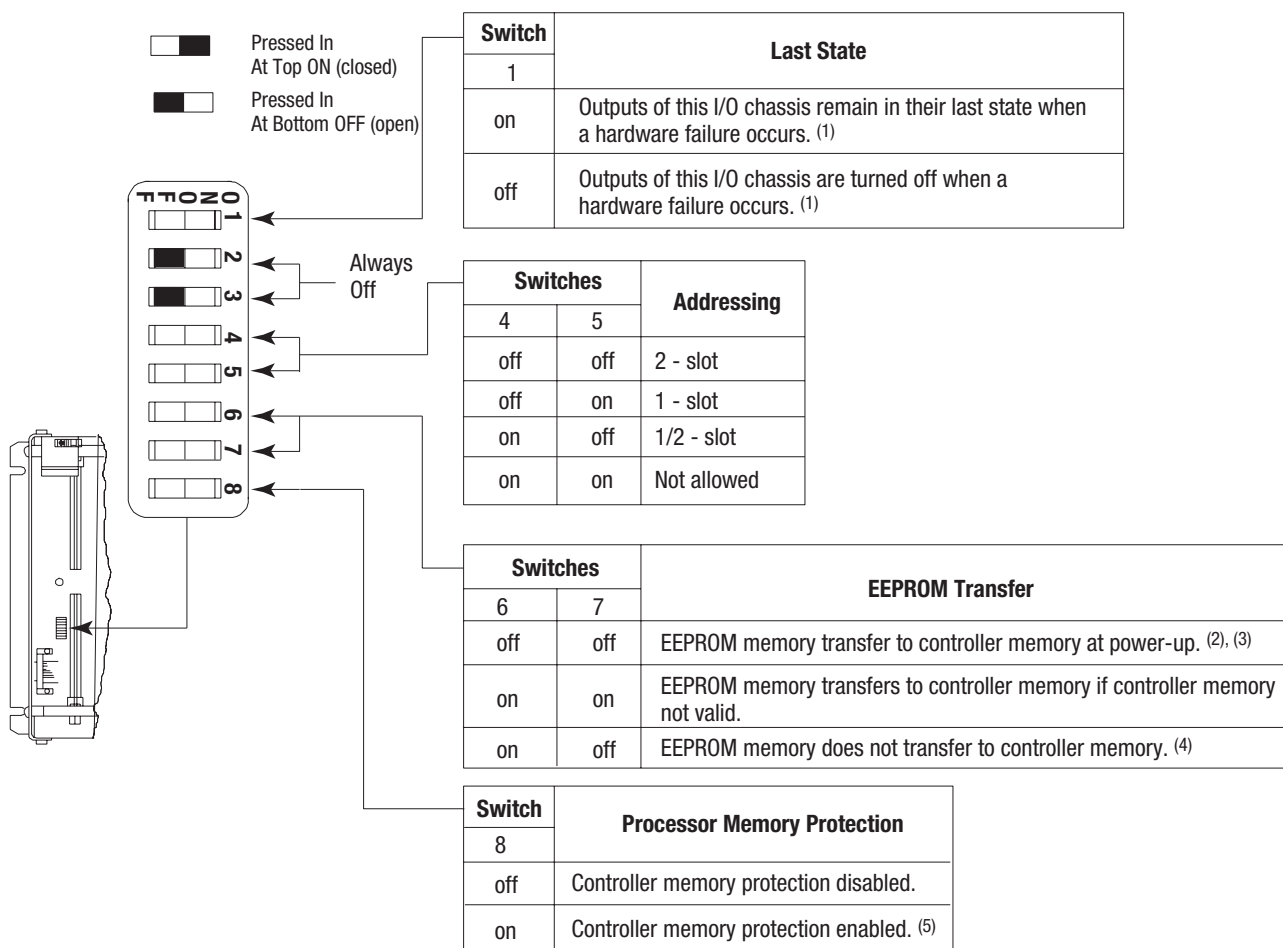

- (1) Regardless of this switch setting, outputs are turned off when any of the following occurs:
  - controller detects a runtime error
  - an I/O chassis backplane fault occurs
  - you select program or test mode
  - you set a status file bit to reset a local rack
- (2) If an EEPROM module is not installed and controller memory is valid, the controller's PROC LED indicator blinks, and the processor sets S:11/9, bit 9 in the major fault status word. To clear this fault, change the controller from program mode to run mode and back to program mode.
- (3) If the controller's keyswitch is set in REMote, the controller enters remote RUN after it powers up and has its memory updated by the EEPROM module.
- (4) A processor fault (solid red PROC LED) occurs if processor memory is not valid.
- (5) You cannot clear processor memory when this switch is on.

- Set the power-supply configuration jumper and set the keying bands as shown below.

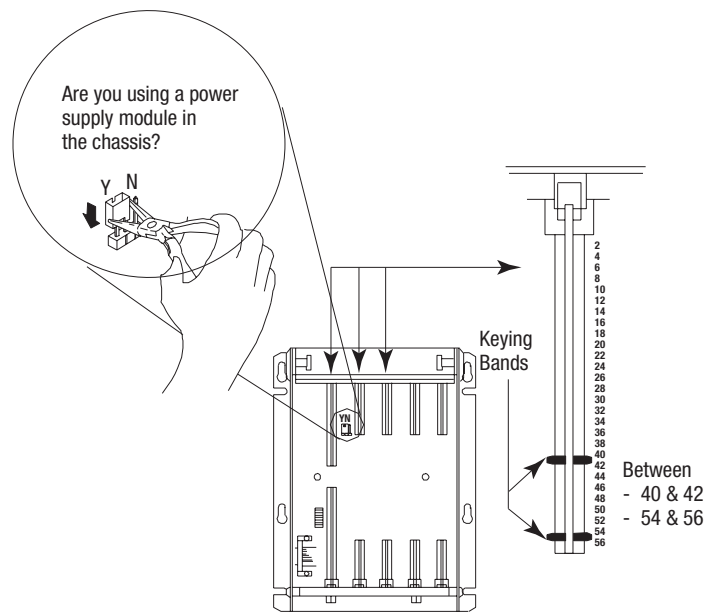

43912

### ***Install the Power Supply***

Install a power supply according to one of the following corresponding installation instructions.

<b>Install This Power Supply</b>	<b>According to this Publication</b>
1771-P4S 1771-P6S 1771-P4S1 1771-P6S1	Power Supply Modules Installation Instructions, publication 1771-2.135
1771-P7	Power Supply Module Installation Instructions, publication 1771-IN056



## Install the PLC-5 Programmable Controller

The controller is a modular component of the 1771 I/O system requiring a properly installed system chassis. Refer to publication 1771-IN075 for detailed information on acceptable chassis along with proper installation and grounding requirements. Limit the maximum adjacent slot power dissipation to 10 W.

1. Define the DH+ Station Address of Channel 1A by setting switch assembly SW-1 on the back of the controller.

See the side of the controller for a listing of DH+ switch settings.

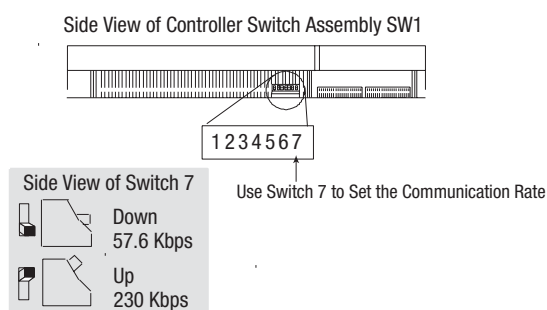

2. Specify the Channel 0 port configuration. See the side of the controller for a listing of Channel 0 switch settings.

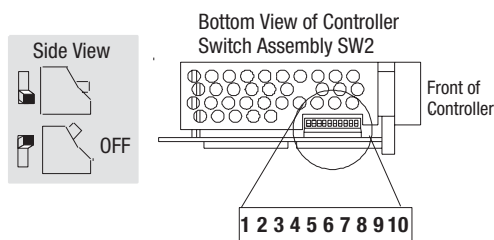

43914

3. To install the battery, attach the battery-side connector into the controller-side connector inside the battery compartment of the controller.

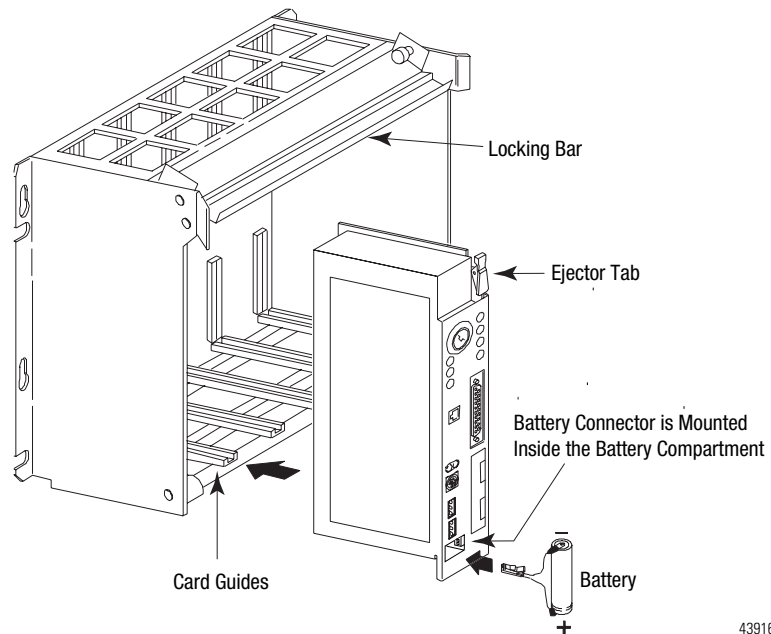

43916

**WARNING**

When you connect or disconnect the battery, an electrical arc can occur. This could cause an explosion in hazardous location installations. Be sure that power is removed or the area is nonhazardous before proceeding. For safety information on the handling of lithium batteries, including handling and disposal of leaking batteries, see Guidelines for Handling Lithium Batteries, publication AG-5.4.

4. Install the controller.

For more information, see the Enhanced and Ethernet PLC-5 Programmable Controllers User Manual, publication 1785-UM012.

***Apply Power to the System***

When you apply power to a new controller, it is normal for the programming software to indicate a RAM fault.

See the following table to proceed. If the PROC LED is not off, turn to the next page for troubleshooting information.

<b>If Your Keyswitch is in This Position</b>	<b>Do This</b>
PROGRAM	Clear memory. The PROC LED should turn off. The software is in Program mode.
REMOTE	Clear memory. The PROC LED should turn off. The software is in Remote Program mode.
RUN	You see the message No access or privilege violation because you cannot clear memory in Run mode. Change the keyswitch position to Program or Remote and press Enter to clear memory.

To monitor your system as you configure and run it, check the controller's indicators:

<b>This Indicator</b>	<b>Lights When</b>
COMM	You establish serial communication (CH 0)
BATT	No battery is installed or the battery voltage is low
FORCE	Forces are present in your ladder program

If your controller is operating correctly, the:

- Ethernet STAT indicator remains solid green
- Ethernet Transmit indicators (100 M and 10 M) briefly light green when transmitting packets

If the indicators do not indicate the above normal operation, refer to the following table to troubleshoot the Ethernet indicators.

### Connect the Personal Computer to the PLC-5 Programmable Controller

For more information, see:

- Enhanced and Ethernet PLC-5 Programmable Controllers User Manual, publication 1785-UM012
- the documentation provided with your communication card
- Data Highway/Data Highway Plus/Data Highway II/Data Highway 485 Cable Installation Manual, publication 1770-6.2.2

### Troubleshoot the Controller

Use the controller's status indicators with the following tables for diagnostics and troubleshooting.

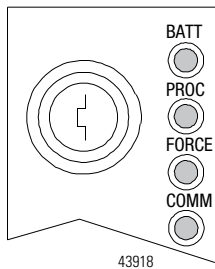

Indicator	Color	Description	Probable Cause	Recommended Action
BATT	Red	Battery low	Battery low	Replace battery within 10 days
	Off	Battery is good	Normal operation	No action required
PROC	Green (steady)	Processor is in Run mode and fully operational	Normal operation	No action required
	Green (blinking)	Processor memory is being transferred to EEPROM	Normal operation	No action required
	Red (blinking)	Major fault	RSLogix 5 download in progress	During RSLogix 5 download, this is normal operation - wait for download to complete.
			Run-time error	If not during RSLogix 5 download:  Check major fault bit in status file (S:11) for error definition  Clear fault, correct problem, and return to Run mode
Alternating Red and Green	Processor in FLASH-memory Programming mode	Normal operation if processor's FLASH memory is being reprogrammed	No action required - allow flash update to complete	

Continued on next page

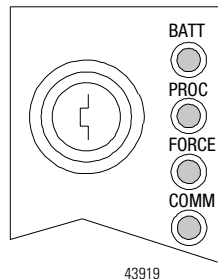

Indicator	Color	Description	Probable Cause	Recommended Action
PROC	Red  (steady)	Fault with memory loss	New controller  Processor has failed internal diagnostics  Power cycle with battery problem.	Use programming software to clear and initialize memory  Install battery (to preserve failure diagnostics), then power down, reseal controller and cycle power; then reload your program. If you are unable to reload your program, replace the controller. If you are able to reload your program and fault persists, contact Technical Support at 440.646.3223 to diagnose the problem. Properly replace or install battery.
	Off	Processor is in program load or Test mode or is not receiving power	Power supply or connections	Check power supply and connections
FORCE	Amber  (steady)	SFC and/or I/O forces enabled	Normal operation	No action required
	Amber (blinking)	SFC and/or I/O forces present but not enabled		
	Off	SFC and/or I/O forces not present		
COMM	Off	No transmission on channel 0	Normal operation if channel is not being used	No action required
	Green (blinking)	Transmission on channel 0	Normal operation if channel is being used	

### Troubleshoot the Controller Communication Channels

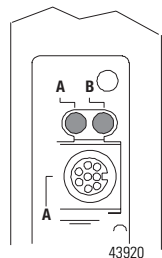

Indicator	Color	Channel Mode	Description	Probable Cause	Recommended Action
A or B	Green (steady)	Remote I/O Scanner	Active Remote I/O link, all adapter modules are present and not faulted	Normal operation	No action required
		Remote I/O Adapter	Communicating with scanner		
		DH+	Controller is transmitting or receiving on DH+ link		
	Green (blinking rapidly or slowly)	Remote I/O Scanner	At least one adapter is faulted or has failed	Power off at remote rack	Restore power to the rack
		DH+	No other nodes on network	Cable broken	Repair cable
	Red (steady)	Remote I/O Scanner Remote I/O Adapter DH+	Hardware fault	Hardware error	Turn power off, then on.  Check that the software configurations match the hardware set-up.  Replace the controller.
Red (blinking rapidly or slowly)		Remote I/O Scanner	Faulted adapters detected	Cable not connected or is broken  Power off at remote racks	Repair cable  Restore power to racks
	DH+	Bad communication on DH+	Duplicate node detected	Correct station address	
Off	Remote I/O Scanner Remote I/O Adapter DH+	Channel offline	Channel is not being used	Place channel online if needed	

### Troubleshoot the Ethernet Status Indicators

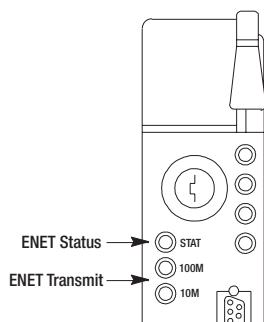

Indicator	Color	Description	Probable Cause	Recommended Action
STAT	Solid red	Critical hardware fault	Controller requires internal repair	Contact your local Allen-Bradley distributor
	Blinking red	Hardware or software fault (detected and reported via a code)	Fault-code dependent	Contact Technical Support at 440.646.3223 to diagnose the problem.
	Off	Module is functioning properly but it is not attached to an active Ethernet network	Normal operation	Attach the controller and interface module to an active Ethernet network
	Solid Green	Ethernet channel 2 is functioning properly and has detected that it is connected to an active Ethernet network	Normal operation	No action required
100 M or 10 M	Green	Lights (green) briefly when the Ethernet port is transmitting a packet. It does not indicate whether or not the Ethernet port is receiving a packet.		

## Controller Specifications

Operating Temperature	IEC 60068-2-1 (Test Ad, Operating Cold), IEC 60068-2-2 (Test Bd, Operating Dry Heat), IEC 60068-2-14 (Test Nb, Operating Thermal Shock): 0...60 °C (32...140 °F)
Nonoperating Temperature	IEC 60068-2-1 (Test Ab, Un-packaged Nonoperating Cold), IEC 60068-2-2 (Test Bc, Un-packaged Nonoperating Dry Heat), IEC 60068-2-14 (Test Na, Un-packaged Nonoperating Thermal Shock): -40...85 °C (-40...185 °F)
Relative Humidity	IEC 60068-2-30 (Test Db, Un-packaged Nonoperating Damp Heat): 5...95% Noncondensing
Vibration	IEC 60068-2-6 (Test Fc, Operating): 2 g @ 10...500Hz
Operating Shock	IEC 60068-2-27:1987, (Test Ea, Unpackaged shock): 30 g
Nonoperating Shock	IEC 60068-2-27:1987, (Test Ea, Unpackaged shock): 50 g
Emissions	CISPR 11: Group 1, Class A (with appropriate enclosure)
ESD Immunity	IEC 61000-4-2: 6 kV indirect contact discharges
Radiated RF Immunity	IEC 61000-4-3: 10 V/m with 1 kHz sine-wave 80% AM from 30...2000 MHz 10 V/m with 200 Hz Pulse 50% AM from 100% AM at 900 MHz 10 V/m with 200 Hz Pulse 50% AM from 100% AM at 1890 MHz 1V/m with 1 kHz sine-wave 80%AM from 2000...2700 MHz
EFT/B Immunity	IEC 61000-4-4: ±2 kV at 5 kHz on communications ports
Surge Transient Immunity	IEC 61000-4-5: ±2 kV line-earth (CM) on communications ports
Conducted RF Immunity	IEC 61000-4-6: 10V rms with 1 kHz sine-wave 80% AM from 150 kHz...80 MHz
Enclosure Type Rating	None (open style)
Power Consumption	3.6 A @5V dc max
Power Dissipation	18.9 W max
Isolation (continuous voltage rating)	50V Basic Insulation between communication ports and between communication ports and backplane Tested to withstand 500V rms for 60 s
Wire Size	Ethernet: 802.3 compliant shielded or unshielded twisted pair Remote I/O: 1770-CD cable Serial Ports: Belden 8342 or equivalent
Wiring Category <sup>(1)</sup>	2 - on communications ports
Replacement Battery	1770-XYC
North American Temp Code	T4A

Specifications continued on next page

<sup>(1)</sup> Use this Conductor Category information for planning conductor routing. Refer to Industrial Automation Wiring and Grounding Guidelines, publication 1770-4.1.



## Controller Specifications (continued)

Time-of-day Clock/Calendar <sup>(1)</sup>	Maximum Variations at 60× C: ± 5 min per month Typical Variations at 20× C: ± 20 s per month Timing Accuracy: 1 program scan
Available Cartridges	1785-RC Relay Cartridge
Memory Modules	<ul style="list-style-type: none"> <li>• 1785-ME16</li> <li>• 1785-ME32</li> <li>• 1785-ME64</li> <li>• 1785-M100</li> </ul>
I/O Modules	Bulletin 1771 I/O, 1794 I/O, 1746 I/O, and 1791 I/O including 8-, 16-, 32-pt, and intelligent modules
Hardware Addressing	2-slot <ul style="list-style-type: none"> <li>• Any mix of 8-pt modules</li> <li>• 16-pt modules must be I/O pairs</li> <li>• No 32-pt modules</li> </ul> 1-slot <ul style="list-style-type: none"> <li>• Any mix of 8- or 16-pt modules</li> <li>• 32-pt modules must be I/O pairs</li> </ul> 1/2-slot—Any mix of 8-, 16-, or 32-pt modules
Location	1771-A1B, -A2B, -A3B, -A3B1, -A4B chassis; leftmost slot
Weight	3 lb, 1 oz (1.39 kg)
Certifications <sup>(2)</sup> (when product is marked)	UL UL Listed Industrial Control Equipment. See UL File E65584. CSA CSA Certified Process Control Equipment. See CSA File LR54689C. CSA CSA Certified Process Control Equipment for Class I, Division 2 Group A,B,C,D Hazardous Locations. See CSA File LR69960C. CE European Union 2004/108/EC EMC Directive, compliant with: EN 50082-2; Industrial Immunity EN 61326; Meas./Control/Lab., Industrial Requirements EN 61000-6-2; Industrial Immunity EN 61000-6-4; Industrial Emissions C-Tick Australian Radiocommunications Act, compliant with: AS/NZS CISPR 11; Industrial Emissions EtherNet/IP ODVA conformance tested to EtherNet/IP specifications

<sup>(1)</sup>The clock/calendar will update appropriately each year.

<sup>(2)</sup>See the Product Certification link at [www.ab.com](http://www.ab.com) for Declarations of Conformity, Certificates, and other certification details.

## Battery Type

Ethernet PLC-5 programmable controllers use 1770-XYC batteries that contain 0.65 grams of lithium.

### Average Battery Lifetime Specifications

In This Controller:	At This Temperature	Worst-case Battery Life Estimates		
		Power Off 100%	Power Off 50%	Battery Duration After The LED lights <sup>(1)</sup>
PLC-5/20E, -5/40E, -5/80E	60 °C	84 days	150 days	5 days
	25 °C	1 year	1.2 years	30 days

<sup>(1)</sup>The battery indicator (BATT) warns you when the battery is low. These durations are based on the battery supplying the only power to the controller (power to the chassis is off) once the LED first lights.

## Memory and Channel Specifications

This table lists memory and channel specifications of each Ethernet PLC-5 programmable controller.

Cat. No.	Max User Memory (words)	Total I/O Max	Channels	Max Number of I/O Chassis				Power Dissipation, Max	Backplane Current Load
				Total	Extended -Local	Remote	ControlNet		
1785-L20E	16 k	512 any mix <b>or</b> 512 in + 512 out (complement)	1 Ethernet 1 DH+ 1 DH+/remote I/O	13	0	12	0	19 W	3.6 A
1785-L40E	48 k	2048 any mix <b>or</b> 2048 in + 2048 out (complement)	1 Ethernet 2 DH+/remote I/O	61	0	60	0	19 W	3.6 A
1785-L80E	100 k	3072 any mix <b>or</b> 3072 in + 3072 out (complement)	1 Ethernet 2 DH+/remote I/O	65	0	64	0	19 W	3.6 A

Allen-Bradley, Data Highway, Data Highway II, DH+, PLC-5, and RSLogix 5 are trademarks of Rockwell Automation, Inc.

Trademarks not belonging to Rockwell Automation are property of their respective companies.

## Notes

## Rockwell Automation Support

Rockwell Automation provides technical information on the web to assist you in using our products. At <http://support.rockwellautomation.com>, you can find technical manuals, a knowledge base of FAQs, technical and application notes, sample code and links to software service packs, and a MySupport feature that you can customize to make the best use of these tools.

For an additional level of technical phone support for installation, configuration and troubleshooting, we offer TechConnect Support programs. For more information, contact your local distributor or Rockwell Automation representative, or visit <http://support.rockwellautomation.com>.

## Installation Assistance

If you experience a problem with a hardware module within the first 24 hours of installation, please review the information that's contained in this manual. You can also contact a special Customer Support number for initial help in getting your module up and running:

United States	1.440.646.3223 Monday – Friday, 8am – 5pm EST
Outside United States	Please contact your local Rockwell Automation representative for any technical support issues.

## New Product Satisfaction Return

Rockwell tests all of our products to ensure that they are fully operational when shipped from the manufacturing facility. However, if your product is not functioning and needs to be returned:

United States	Contact your distributor. You must provide a Customer Support case number (see phone number above to obtain one) to your distributor in order to complete the return process.
Outside United States	Please contact your local Rockwell Automation representative for return procedure.

[www.rockwellautomation.com](http://www.rockwellautomation.com)

### Power, Control and Information Solutions Headquarters

Americas: Rockwell Automation, 1201 South Second Street, Milwaukee, WI 53204-2496 USA, Tel: (1) 414.382.2000, Fax: (1) 414.382.4444

Europe/Middle East/Africa: Rockwell Automation, Vorstlaan/Boulevard du Souverain 36, 1170 Brussels, Belgium, Tel: (32) 2 663 0600, Fax: (32) 2 663 0640

Asia Pacific: Rockwell Automation, Level 14, Core F, Cyberport 3, 100 Cyberport Road, Hong Kong, Tel: (852) 2887 4788, Fax: (852) 2508 1846